



Operation Manual

Goodrive100-PV Series Solar Pumping Inverter



SHENZHEN INVT ELECTRIC CO., LTD.

Contents

Contents	i
1 Safety precautions	1
1.1 Safety definition	1
1.2 Warning symbols	1
1.3 Safety guidelines	2
2 Product overview	4
2.1 Unpacking inspection	4
2.2 Name plate	4
2.3 Type designation key	4
2.4 Product specifications	5
2.5 Rated specifications	6
3 Installation guidelines	7
3.1 Mechanical installation	7
3.2 Standard wiring	9
4 Keypad operation procedure	14
4.1 Keypad introduction	14
4.2 Keypad displaying	17
4.3 Keypad operation	18
5 Commissioning guidelines	20
5.1 Inspection before operation	20
5.2 Trial run	20
5.3 Parameter settings	20
5.4 Advanced settings	20
6 Function parameters	22
6.1 Common function parameters for solar pumping inverter control	22
6.2 Parameters of special functions	41
7 Fault diagnosis and solution	59
Appendix A Options and use	65
A.1 Boost module	65
A.2 GPRS module and monitoring APP	66
A.3 Cables	67
A.4 Reactors	69
A.5 Filters	70
Appendix B Recommended solar modules	71
B.1 Recommended configuration for solar pumping inverters	71
B.2 Recommended configuration for inverters with the boost module	72
Appendix C Power frequency & PV switching solution	73
C.1 Solution introduction	73
C.2 IP54 protection-level inverters	77
C.3 Wiring terminals	78
C.4 Parameter setting method	79
Appendix D Dimension drawings	80
D.1 External keypad structure	80
D.2 Dimensions of 0.4-2.2kW models	81
D.3 Dimensions of 1.5-200kW models	83
Appendix E Further information	86
E.1 Product and service inquiries	86
E.2 Feedback of INVT Inverters manuals	86
E.3 Document library on the Internet	86

1 Safety precautions

Please read this manual carefully and follow all safety precautions before moving, installing, operating and servicing the inverter. If ignored, physical injury or death may occur, or damage may occur to the devices.









If any physical injury or death or damage to the devices occurs for ignoring to the safety precautions in the manual, our company will not be responsible for any damages and we are not legally bound in any manner.

1.1 Safety definition





Danger:	Serious physical injury or even death may occur if not follow relevant requirements
Warning:	Physical injury or damage to the devices may occur if not follow relevant requirements
Note:	Physical hurt may occur if not follow relevant requirements
Qualified electricians:	People working on the device should take part in professional electrical and safety training, receive the certification and be familiar with all steps and requirements of installing, commissioning, operating and maintaining the device to avoid any emergency.

1.2 Warning symbols

Warnings caution you about conditions which can result in serious injury or death and/or damage to the equipment, and advice on how to avoid the danger. Following warning symbols are used in this manual:

Symbols	Name	Instruction	Abbreviation
 Danger	Danger	Serious physical injury or even death may occur if not follow the relative requirements	
 Warning	Warning	Physical injury or damage to the devices may occur if not follow the relative requirements	
 Do not	Electrostatic discharge	Damage to the PCBA board may occur if not follow the relative requirements	
 Hot sides	Hot sides	Sides of the device may become hot. Do not touch.	
Note	Note	Physical hurt may occur if not follow the relative requirements	Note

1.3 Safety guidelines

	<ul style="list-style-type: none"> ◇ Only qualified electricians are allowed to operate on the inverter. ◇ Do not carry out any wiring and inspection or changing components when the power supply is applied. Ensure all input power supply is disconnected before wiring and checking and always wait for at least the time designated on the inverter or until the DC bus voltage is less than 36V. Below is the table of the waiting time: 		
	Inverter model		Minimum waiting time
	1PH 220V	0.4kW-2.2kW	5 minutes
	3PH 220V	1.5kW-7.5kW	5 minutes
	3PH 380V	0.75kW-110kW	5 minutes
3PH 380V	132kW-200kW	15 minutes	
	<ul style="list-style-type: none"> ◇ Do not refit the inverter unauthorized; otherwise fire, electric shock or other injury may occur. 		
	<ul style="list-style-type: none"> ◇ The base of the radiator may become hot during running. Do not touch to avoid hurt. 		
	<ul style="list-style-type: none"> ◇ The electrical parts and components inside the inverter are electrostatic. Take measurements to avoid electrostatic discharge during relevant operation. 		

1.3.1 Delivery and installation

	<ul style="list-style-type: none"> ◇ Please install the inverter on fire-retardant material and keep the inverter away from combustible materials. ◇ Do not operate on the inverter if there is any damage or components loss to the inverter. ◇ Do not touch the inverter with wet items or body, otherwise electric shock may occur.
--	---

Note:

- ◇ Select appropriate moving and installing tools to ensure a safe and normal running of the inverter and avoid physical injury or death. For physical safety, the erector should take some mechanical protective measurements, such as wearing safety shoes and working uniforms.
- ◇ Do not carry the inverter by its cover. The cover may fall off.
- ◇ Ensure to avoid physical shock or vibration during delivery and installation.
- ◇ Install away from children and other public places.
- ◇ The inverter cannot meet the requirements of low voltage protection in IEC61800-5-1 if the altitude of installation site is above 2000m.
- ◇ The leakage current of the inverter may be above 3.5mA during operation. Ground with proper techniques and ensure the grounding resistor is less than 10Ω. The conductivity of PE grounding conductor is the same as that of the phase conductor (with the same

cross sectional area).

- ◇ (+) and (-) are DC power supply input terminals. R, S and T (L,N) are AC power supply input terminals. U, V and W are output terminals. Please connect the input power cables and motor cables with proper techniques; otherwise the damage to the inverter may occur.

1.3.2 Commissioning and running

	<ul style="list-style-type: none"> ◇ Disconnect all power supplies applied to the inverter before the terminal wiring and wait for at least the designated time after disconnecting the power supply. ◇ High voltage is present inside the inverter during running. Do not carry out any operation except for the keypad setting. ◇ The inverter cannot be used as "Emergency-stop device". If the inverter is used to break the motor suddenly, a mechanical braking device should be provided.
--	---

Note:

- ◇ Do not switch on or off the input power supply of the inverter frequently.
- ◇ For inverters that have been stored for a long time, check and fix the capacitance and try to run it again before utilization.
- ◇ Cover the front board before running, otherwise electric shock may occur.



1.3.3 Maintenance and replacement of components

	<ul style="list-style-type: none"> ◇ Only qualified electricians are allowed to perform the maintenance, inspection, and components replacement of the inverter. ◇ Disconnect all power supplies to the inverter before the terminal wiring. Wait for at least the time designated on the inverter after disconnection. ◇ Take measures to avoid screws, cables and other conductive materials to fall into the inverter during maintenance and component replacement.
--	---

Note:

- ◇ Please select proper torque to tighten screws.
- ◇ Keep the inverter, parts and components away from combustible materials during maintenance and component replacement.
- ◇ Do not carry out any isolation voltage-endurance test on the inverter and do not measure the control circuit of the inverter by megameter.

1.3.4 Scrap treatment

	<ul style="list-style-type: none"> ◇ There are heavy metals in the inverter. Deal with it as industrial effluent.
	<ul style="list-style-type: none"> ◇ When the life cycle ends, the product should enter the recycling system. Dispose of it separately at an appropriate collection point instead of placing it in the normal waste stream.

2 Product overview

2.1 Unpacking inspection

Check as follows after receiving products:

1. Check that there are no damage and humidification to the package. If not, please contact with local agents or INVT offices.
2. Check the information on the type designation label on the outside of the package to verify that the drive is of the correct type. If not, please contact with local dealers or INVT offices.
3. Check that there are no signs of water in the package and no signs of damage or breach to the inverter. If not, please contact with local dealers or INVT offices.
4. Check the information on the type designation label on the outside of the package to verify that the name plate is of the correct type. If not, please contact with local dealers or INVT offices.
5. Check to ensure the accessories (including user's manual and control keypad) inside the device is complete. If not, please contact with local dealers or INVT offices.

2.2 Name plate

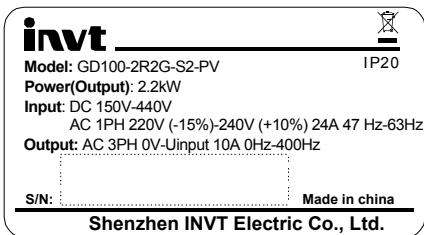

Figure 2-1 Name plate

Note: This is the example of Goodrive100-PV standard products and the CE\TUV\IP20 certifications are marked according to the reality.

2.3 Type designation key

The type designation contains information on the inverter. The user can find the type designation on the type designation label attached to the inverter or the simple name plate.

GD100 - 5R5G - 45 - PV

①

②

③

④

⑤

Key	Sign	Description	Remarks
Product abbreviation	①	Product abbreviation	GD100 is short for Goodrive100.
Rated power	②	Power range + Load type	5R5G—5.5kW G—Constant torque load
Voltage degree	③	Voltage degree	4: AC 3PH 380V (-15%)—440(+10%) 2: AC 3PH 220V (-15%)—240(+10%) S2: AC 1PH 220V (-15%)—240(+10%) SS2: AC 1PH input/output 220V (-15%)—240(+10%)
Protection level	④	Protection level	Protection level. 5—IP54 The protection level of a standard inverter is IP20, but this field is not displayed.
Industrial code	⑤	Industrial code	PV stands for solar pumping.

2.4 Product specifications

Model	-SS2	-S2	-2	-4
AC input voltage (V)	220 (-15%)—240 (+10%) (1PH)		220 (-15%)— 240 (+10%) (3PH)	380 (-15%)— 440 (+10%) (3PH)
Max. DC voltage (V)	440	440	440	800
Start-up voltage (V)	200	200	200	300
Lowest working voltage (V)	150	150	150	250
Recommended DC input voltage range (V)	200—400	200—400	200—400	300—750
Recommended MPP voltage (V)	330	330	330	550

2.5 Rated specifications

Series	Model	Rated output power (Kw)	Rated input current (A)	Rated output current (A)	Max. DC input current (A)
-SS2 model 1PH 220V Input/output (0.4-2.2 kW)	GD100-0R4G-SS2-PV	0.4	6.5	4.2	9
	GD100-0R7G-SS2-PV	0.75	9.3	7.2	9
	GD100-1R5G-SS2-PV	1.5	15.7	10.2	12
	GD100-2R2G-SS2-PV	2.2	24	14	12
-S2 model 1PH 220V input (0.4-2.2 kW)	GD100-0R4G-S2-PV	0.4	6.5	2.5	9
	GD100-0R7G-S2-PV	0.75	9.3	4.2	9
	GD100-1R5G-S2-PV	1.5	15.7	7.5	12
	GD100-2R2G-S2-PV	2.2	24	10	12
-2 model 3PH 220V (1.5-7.5kW)	GD100-1R5G-2-PV	1.5	7.7	7.5	12
	GD100-2R2G-2-PV	2.2	11	10	12
	GD100-004G-2-PV	4	17	16	20
	GD100-5R5G-2-PV	5.5	25	20	30
	GD100-7R5G-2-PV	7.5	33	30	40
-4 model 3PH 380V (0.75-200kW)	GD100-0R7G-4-PV	0.75	3.4	2.5	9
	GD100-1R5G-4-PV	1.5	5.0	4.2	9
	GD100-2R2G-4-PV	2.2	5.8	5.5	12
	GD100-004G-4-PV	4.0	13.5	9.5	16.5
	GD100-5R5G-4-PV	5.5	19.5	14	23.9
	GD100-7R5G-4-PV	7.5	25	18.5	30.6
	GD100-011G-4-PV	11	32	25	39.2
	GD100-015G-4-PV	15	40	32	49
	GD100-018G-4-PV	18.5	47	38	50
	GD100-022G-4-PV	22	51	45	60
	GD100-030G-4-PV	30	70	60	81
	GD100-037G-4-PV	37	80	75	90
	GD100-045G-4-PV	45	98	92	130
	GD100-055G-4-PV	55	128	115	150
	GD100-075G-4-PV	75	139	150	200
	GD100-090G-4-PV	90	168	180	250
	GD100-110G-4-PV	110	201	215	300
	GD100-132G-4-PV	132	265	260	360
	GD100-160G-4-PV	160	310	305	430
GD100-185G-4-PV	185	345	340	500	
GD100-200G-4-PV	200	385	380	550	

3 Installation guidelines

The chapter describes the mechanical installation and electric installation.

	<ul style="list-style-type: none"> ◇ Only qualified electricians are allowed to carry out what described in this chapter. Please operate as the instructions in Safety precautions. Ignoring these may cause physical injury or death or damage to the devices. ◇ Ensure the power supply of the inverter is disconnected during the operation. Wait for at least the time designated after the disconnection if the power supply is applied. ◇ The installation and design of the inverter should be complied with the requirement of the local laws and regulations in the installation site. If the installation infringes the requirement, our company will exempt from any responsibility. Additionally, if users do not comply with the suggestion, some damage beyond the assured maintenance range may occur.
--	---

3.1 Mechanical installation

3.1.1 Installation environment

The installation environment is the safeguard for a full performance and long-term stable functions of the inverter. Check the installation environment as follows:

Environment	Conditions
Installation site	Indoor
Environment temperature	<p>The ambient temperature of inverter is -10°C–50°C while air temperature change should be less than 0.5°C per minute.</p> <p>The inverter will be derated once ambient temperature exceeds 40°C. It is not recommended to use the inverter if ambient temperature is above 50°C.</p> <p>To ensure reliability, do not use the inverter if the ambient temperature changes frequently.</p> <p>Provide cooling fan or air conditioner to control the internal ambient temperature below the required one if the inverter is used in a close space such as in the control cabinet.</p> <p>When the temperature is too low, if the inverter needs to restart to run after a long stop, it is necessary to provide an external heating device to increase the internal temperature, otherwise damage to the devices may occur.</p>
Humidity	RH \leq 90%. No condensation is allowed.
Storage temperature	-40°C – 70°C . The temperature change rate is less than $1^{\circ}\text{C}/\text{minute}$.

Environment	Conditions
Running environment condition	The installation site of the inverter should: Keep away from the electromagnetic radiation source; Keep away from contaminative air, such as corrosive gas, oil mist and flammable gas; Ensure foreign objects, such as metal power, dust, oil, water cannot enter into the inverter (do not install the inverter on the flammable materials such as wood); Keep away from direct sunlight, oil mist, steam, and vibration environment.
Pollution	Pollution degree 2
Altitude	When the altitude exceeds 1000m but is lower than 3000m, derate 1% for every additional 100m; When the altitude exceeds 2000m, configure an isolation transformer on the input end of the inverter. When the altitude exceeds 3000m but is lower than 5000m, contact our company for technical consultation. Do not use the inverter at an altitude higher than 5000m.
Vibration	$\leq 5.8\text{m/s}^2(0.6\text{g})$
Installation direction	The inverter should be installed on an upright position to ensure sufficient cooling effect.

Note:

- Goodrive100-PV series inverters should be installed in a clean and ventilated environment according to enclosure classification.
- Cooling air must be clean, free from corrosive materials and electrically conductive dust.

3.1.2 Installation direction

The inverter may be installed on the wall or in a cabinet.

The inverter needs be installed in the vertical position. Check the installation site according to the requirements below. See **Appendix D Dimension drawings** for frame details.

3.1.3 Installation manner

(1) The inverters $\leq 2.2\text{kW}$ support wall mounting and rail mounting.

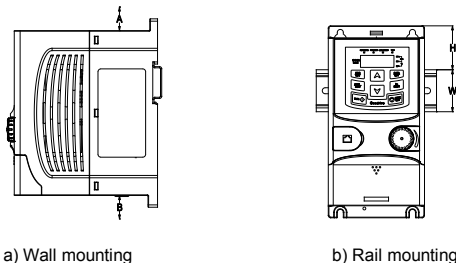

a) Wall mounting

b) Rail mounting

Figure 3-1 Installation manners

Note: The minimum space of A and B is 100mm. H is 36.6mm and W is 35.0mm.

(2) The inverters $\geq 4\text{kW}$ support wall mounting and flange mounting.

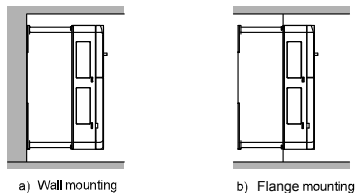

a) Wall mounting

b) Flange mounting

Figure 3-2 Installation manners

1) Mark the locations of installation holes. For details about the holes, see the inverter dimension diagram in the appendix.

2) Fix the screws or bolts into the marked locations.

3) Lean the inverter against the wall.

4) Fasten the tightening screws on the wall.

3.2 Standard wiring

3.2.1 Terminals of main circuit

The figure below shows the standard wiring of inverter.

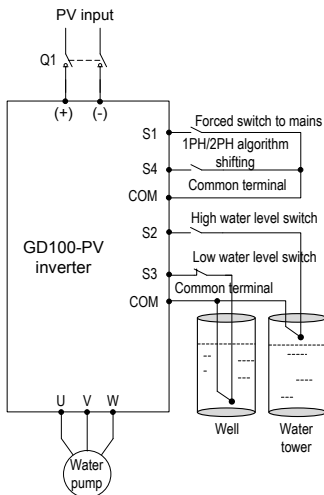



Figure 3-3 Standard wiring diagram



- ◇ The DC breaker Q1 must be installed as the protection switch for PV input.
- ◇ In parallel connection, the combination box special for PV must be used.
- ◇ When the distance between the PV input component and inverter exceeds 10 meters, type-II surge protection devices must be configured at the DC side.
- ◇ When the distance between the pump and inverter exceeds 50 meters, it is recommended to configure output reactors. See appendix A.4 for the output reactor model selection.
- ◇ The inverter automatically runs after being powered on. If parameters need to be set, follow the parameter setting instructions in chapter 5.
- ◇ Before connecting the braking resistor cable, remove the yellow labels of PB, (+), and (-) from the terminal blocks. Otherwise, poor connection may occur.

Terminal	Name	Function
R, S, T (L, N)	AC input	3PH (1PH) AC input terminals, connected to the grid Note: Use the screws equipped with the inverter for wiring.
(+), (-)	PV input	Solar cell panel input terminals
U, V, W	Inverter output	3PH/1PH AC output terminals, connected to the pump motor Note: 1PH motors must connect to terminals U and W.
	Safety grounding	Safety protection grounding terminal. Each inverter must be grounded

Description for -SS2 single-phase output models

1) Generally, the output terminals U and W of the inverter connect to the phase cables of the single-phase motor.

2) If the single-phase pump cannot be started, the two-phase control method must be used, and the start-up and running capacitors (if any) of the motor must be removed. The figure below shows the internal wiring of the common single-phase motor. In the figure, L1, L2, C1, and C2 indicate the running winding, start-up winding, running capacitor, and start-up capacitor. When the motor speed exceeds 75% of the rated speed, the start-up capacitor is switched off.

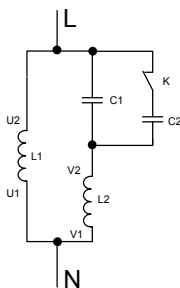

Internal wiring of the single-phase motor winding after removing the starting and running capacitor:

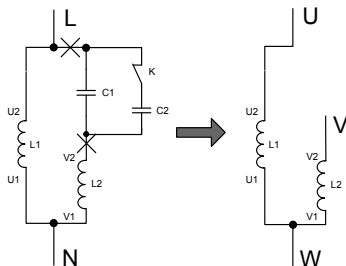

U1 and V1 are the common terminals of the windings. Connect them to the output terminal W of the solar pumping inverter. Connect U2 to the output terminal U of the inverter. Connect V2 to the output terminal V of the inverter. (**Note:** Use the screws equipped with the inverter.) Connect S4 of the inverter to COM in short circuited manner.

3.2.2 Terminals of control circuit

Functions of control terminals

Category	Terminal symbol	Terminal name	Terminal function
Power supply	24V	24V power supply	It provides the power of $24V \pm 10\%$ and maximum current of 200mA.
	COM	Common terminal	It functions as the working power supply of digital input and output or externally connects to the sensor power supply.
Digital input	S1	Forced switch to power frequency	Terminal feature parameters: 1. Internal impedance: 3.3k Ω 2. Acceptable voltage input: 12–24V 3. Maximum input frequency: 1kHz S1: Forcible switch to power
	S2	Full-water alarm	
	S3	Empty-water alarm	

Category	Terminal symbol	Terminal name	Terminal function
	S4	Single/two phase algorithm switching	frequency (Switching-on indicates switching to power frequency, and switching-off indicates input controlled by the keypad.) S2: It connects to the high-water switch of the normally open contact by default. S3: It connects to the low-water switch of the normally closed contact. S4: A high electrical level corresponds to the single-phase algorithm. A low electrical level corresponds to the two-phase algorithm.
Communication	RS485+ RS485-	485 communication	485 communication terminals, using the Modbus protocol
	422TX+ 422TX- 422RX+ 422RX-	422 communication	Communication terminals special for the boost module.
Relay output	RO1A (ROA)	Normally open contact of relay 1	1. Contact capacity: 3A/AC250V, 1A/DC30V 2. They cannot be used for high frequency switch output.
	RO1B (ROB)	Normally closed contact of relay 1	
	RO1C (ROC)	Common terminal of relay 1	During the application of auto power frequency & PV switching, the AC input contactor coil is controlled by the normally closed contact of the relay.

4 Keypad operation procedure

4.1 Keypad introduction

Keypads are used to control GD100-PV series inverters, read the state data and adjust parameters. If it is necessary to connect the keypad to other external device, you can use the standard RJ45 cable with crystal head as the external extension cable.

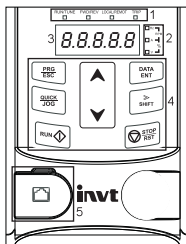

Figure 4-1 Keypad diagram for inverters $\leq 2.2\text{kW}$

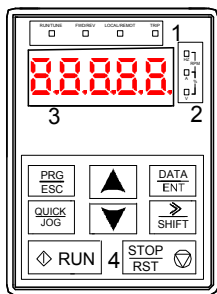
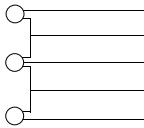









Figure 4-2 Keypad diagram for inverters $\geq 4\text{kW}$

Note: External keypads can be configured for inverters $\leq 2.2\text{kW}$. The keypads of inverters $\geq 4\text{kW}$ can be used as external keypads.

Serial No.	Name	Description		
1	State LED	RUN/TUNE	LED off means that the inverter is in the stopping state; LED blinking means the inverter is in the parameter autotune state; LED on means the inverter is in the running state.	
			FWD/REV	FED/REV LED LED off means the inverter is in the forward rotation state; LED on means the inverter is in the reverse rotation state.
		LOCAL/REMOT	LED for keypad operation, terminals operation and remote communication control LED off means that the inverter is in the keypad operation state; LED blinking means the inverter is in the terminals operation state; LED on means the inverter is in the remote communication control state.	
		TRIP	LED for faults LED on when the inverter is in the fault state; LED off in normal state; LED blinking means the inverter is in the pre-alarm state.	
2	Unit LED	Mean the unit displayed currently		
			Hz	Frequency unit
			RPM	Rotating speed unit
			A	Current unit
			%	Percentage
V	Voltage unit			
3	Display zone	5-figure LED display displays various monitoring data and alarm code such as set frequency and output frequency.		

Serial No.	Name	Description							
		Display	Mean	Display	Mean	Display	Mean	Display	Mean
		0	0	1	1	2	2	3	3
		4	4	5	5	6	6	7	7
		8	8	9	9	A	A	b	B
		C	C	d	D	E	E	F	F
		H	H	I	I	L	L	n	N
		n	n	o	o	P	P	r	r
		S	S	t	t	U	U	v	v
		.	.	-	-				
4	Buttons		Programming key		Enter or escape from the first level menu and remove the parameter quickly.				
			Entry key		Enter the menu step-by-step. Confirm parameters.				
			UP key		Increase data or function code progressively.				
			DOWN key		Decrease data or function code progressively				
			Right-shift key		Move right to select the displaying parameter circularly in stopping and running mode. Select the parameter modifying digit during the parameter modification.				
			Run key		This key is used to operate on the inverter in key operation mode.				
			Stop/Reset key		This key is used to stop in running state and it is limited by function code P07.04 . This key is used to reset all control modes in the fault alarm state.				
			Quick key		The function of this key is confirmed by function code P07.02 .				
5	Keypad port	External keypad port. When keypads are valid, both the local and external keypad LEDs are on.							

4.2 Keypad displaying



The keypad displaying state of GD100-PV series inverters is divided into stopping state parameter, running state parameter, function code parameter editing state and fault alarm state and so on.

4.2.1 Displayed state of stopping parameters

When the inverter is in the stopping state, the keypad will display stopping parameters as shown in figure 4-2.

In the stopping state, various kinds of parameters can be displayed. Select the parameters to be displayed or not by P07.07. See the instructions of P07.07 for the detailed definition of each bit.



In the stopping state, there are 4 parameters that can be displayed. They are: set frequency, bus voltage, input terminals state, and output terminals state.

 /SHIFT can shift the parameters from left to right.  QUICK/JOG (P07.02=2) can shift the parameters from right to left.

4.2.2 Displayed state of running parameters

After the inverter receives valid running commands, the inverter will enter into the running state and the keypad will display the running parameters. RUN/TUNE LED on the keypad is on, while the FWD/REV is determined by the current running direction which is as shown in figure 4-2.

In the running state, there are 6 parameters that can be displayed. They are: running frequency, set frequency, bus voltage, output voltage, output current, and rotating speed. 

 /SHIFT can shift the parameters from left to right.  QUICK/JOG (P07.02=2) can shift the parameters from right to left.

4.2.3 Displayed state of faults

If the inverter detects the fault signal, it will enter into the fault pre-alarm displaying state. The keypad will display the fault code by flicking. The TRIP LED on the keypad is on, and the fault reset can be operated by the  on the keypad, control terminals or communication commands.

4.2.4 Displayed state of function codes editing

In the state of stopping, running or fault, press  to enter into the editing state (if there is a password, see P07.00). The editing state is displayed on two classes of menu, and the order is: function code group/function code number → function code parameter, press

DATA/ENT into the displayed state of function parameter. On this state, press **DATA/ENT** to save the parameters or press **PRG/ESC** to escape.



Figure 4-3 Displayed state

4.3 Keypad operation

Operate the inverter via operation panel. See the detailed structure description of function codes in the brief diagram of function codes.

4.3.1 How to modify the function codes of the inverter

The inverter has three levels menu, which are:

1. Group number of function code (first-level menu)
2. Tab of function code (second-level menu)
3. Set value of function code (third-level menu)

Remarks: Press both the **PRG/ESC** and the **DATA/ENT** can return to the second-level menu from the third-level menu. The difference is: pressing **DATA/ENT** will save the set parameters into the control panel, and then return to the second-level menu with shifting to the next function code automatically; while pressing **PRG/ESC** will directly return to the second-level menu without saving the parameters, and keep staying at the current function code.

Under the third-level menu, if the parameter has no flickering bit, it means the function code cannot be modified. The possible reasons could be:

- 1) This function code is not modifiable parameter, such as actual detected parameter, operation records and so on;
- 2) This function code is not modifiable in running state, but modifiable in stop state.

Example: Set function code **P00.01** from 0 to 1.

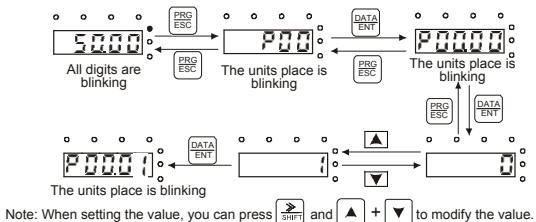

Figure 4-4 Sketch map of modifying parameters

5 Commissioning guidelines



- ✧ Disconnect all power supplies applied to the inverter before the terminal wiring and wait for at least the designated time after disconnecting the power supply.
- ✧ High voltage is present inside the inverter during running. Do not carry out any operation except for the keypad setting.
- ✧ The inverter automatically runs once power on. If parameters need to be set, follow the guidelines in this chapter.

5.1 Inspection before operation

Before powering on the inverter, ensure that:

- a) The inverter is grounded reliably.
- b) The wiring is correct and reliable.
- c) The AC/DC breaker is selected correctly.
- d) The PV input voltage is in the allowed range of the inverter.
- e) The type, voltage, and power of the motor match those of the inverter.

5.2 Trial run

Close the DC breaker. The inverter automatically runs with a delay of 10 seconds. Check the water yield of the pump. If the water yield is normal, the trial run is successful. If the water yield is under the normal value, exchange any two motor cables, connect the cables, and perform trial run again.

5.3 Parameter settings

The inverter automatically runs by default once being powered on. If you want to set parameters, press **QUICK/JOG** within 10 seconds since the inverter power-on to switch to the keypad control mode (**LOCAL/REMOT** is off) and then set parameters. If the running indicator is already on after the inverter is powered on, press **STOP/RST** to enter the parameter setting mode. After parameter setting, turn off and then turn on the power switch. The inverter runs again.

5.4 Advanced settings

Note: The default settings of the inverter for the water pump can apply to most conditions and the advanced settings are not required in most cases.

5.4.1 PI adjustment to the water yield

If the user requires large or low water yield, it is necessary to adjust PI ([P15.06](#)–[P15.10](#))

properly. The bigger PI parameters, the stronger the effect is, but the frequency fluctuation of the motor is bigger. In reserve, the lower the water yield is, the more stable the motor frequency is.

5.4.2 Special settings for single phase motors

a) When the single phase motor is in bad running performance, the user can adjust P04 VF curve settings: set [P04.00](#)=1 and set [P04.03](#)–[P04.08](#) to appropriate values according to commissioning conditions; increase the voltage if the motor cannot start and decrease the voltage if the current is high.

b) When the light is normal and the system starts slowly, increase [P15.28](#) initial voltage differential value appropriately.

c) For single phase motors with two-phase control (capacitor-removing):

① The maximum voltage needs to be less than 1/1.6 of the bus voltage. It is recommended to set the rated voltage [P02.04](#) less than 200V, or limit the maximum voltage output by multi-dot V/F curve.

② Observe the currents of the windings through [P17.38](#) and [P17.39](#), the switched current is the combination current of the two windings. The impedances of the windings are different, so the currents are different at the same voltage output.

③ [P04.35](#) can be used to change the output currents of the main and secondary windings. It is recommended that qualified engineers perform adjustment since the voltage adjustment is associated with motor design parameters. Otherwise, the motor performance may be impacted.

6 Function parameters

“○”: means the set value of the parameter can be modified on stop and running state;

“◎”: means the set value of the parameter cannot be modified on the running state;

“●”: means the value of the parameter is the real detection value which cannot be modified;

Note: The inverter implements auto checking and restriction on the parameter modification property. This prevents users from modifying parameters by misoperation.

6.1 Common function parameters for solar pumping inverter control

Function code	Name	Detailed illustration of parameters	Default	Modify
P00 Group Basic function group				
P00.00	Speed control mode	0: SVC 0 No need to install encoders. Suitable in applications which need low frequency, big torque for high accuracy of rotating speed and torque control. Relative to mode 1, it is more suitable for the applications which need small power. 1: SVC 1 1 is suitable in high performance cases with the advantage of high accuracy of rotating speed and torque. It does not need to install pulse encoder. 2: SVPWM control 2 is suitable in applications which do not need high control accuracy, such as the load of fan and pump, and suitable when one inverter drives multiple motors. Note: In vector control, the inverter must autotune motor parameters first.	2	◎
P00.01	Run command channel	Select the run command channel of the inverter. The control command of the inverter includes: start, stop, forward/reverse	1	○

Function code	Name	Detailed illustration of parameters	Default	Modify
		<p>rotating, jogging and fault reset.</p> <p>0: Keypad running command channel ("LOCAL/REMOT" light off) Carry out the command control by RUN, STOP/RST on the keypad. Set the multi-function key QUICK/JOG to FWD/REV shifting function (P07.02=3) to change the running direction; press RUN and STOP/RST simultaneously in running state to make the inverter coast to stop.</p> <p>1: Terminal running command channel ("LOCAL/REMOT" flickering) Carry out the running command control by the forward rotation, reverse rotation and forward jogging and reverse jogging of the multi-function terminals.</p> <p>2: Communication running command channel ("LOCAL/REMOT" on); The running command is controlled by the upper monitor via communication.</p>		
P00.03	Max. output frequency	<p>This parameter is used to set the maximum output frequency of the inverter. Users need to pay attention to this parameter because it is the foundation of the frequency setting and the speed of acceleration and deceleration.</p> <p>Setting range: P00.04–400.00Hz</p>	50.00Hz	⊙
P00.04	Upper limit of the	The upper limit of the running frequency is	50.00Hz	⊙

Function code	Name	Detailed illustration of parameters	Default	Modify
	running frequency	the upper limit of the output frequency of the inverter which is lower than or equal to the maximum frequency. Setting range: P00.05 – P00.03 (Max. output frequency)		
P00.05	Lower limit of the running frequency	The lower limit of the running frequency is that of the output frequency of the inverter. The inverter runs at the lower limit frequency if the set frequency is lower than the lower limit. Note: Max. output frequency \geq Upper limit frequency \geq Lower limit frequency Setting range: 0.00Hz– P00.04 (Upper limit of the running frequency)	0.00Hz	⊙
P00.11	ACC time 1	ACC time means the time needed if the inverter speeds up from 0Hz to the Max. output frequency (P00.03). DEC time means the time needed if the inverter speeds down from the Max. output frequency to 0Hz (P00.03).	Depend on mode	○
P00.12	DEC time 1	GD100-PV series inverters have four groups of ACC/DEC time which can be selected by P05. The factory default ACC/DEC time of the inverter is the first group. Setting range of P00.11 and P00.12 : 0.0–3600.0s	Depend on mode	○
P00.13	Running direction	0: Runs at the default direction. The	0	○

Function code	Name	Detailed illustration of parameters	Default	Modify
	selection	<p>inverter runs in the forward direction. FWD/REV indicator is off.</p> <p>1: Runs at the opposite direction. The inverter runs in the reverse direction. FWD/REV indicator is on.</p> <p>Modify the function code to shift the rotation direction of the motor. This effect equals to the shifting the rotation direction by adjusting either two of the motor lines (U, V and W). The motor rotation direction can be changed by QUICK/JOG on the keypad. Refer to parameter P07.02.</p> <p>Note:</p> <p>When the function parameter comes back to the default value, the motor's running direction will come back to the factory default state, too.</p> <p>In pump application scenarios, the inverter cannot run in the reverse direction. This function code cannot be modified.</p> <p>2: Forbid to run in reverse direction: It can be used in some special cases if the reverse running is disabled.</p>		
P00.15	Motor parameter autotuning	<p>0: No operation</p> <p>1: Rotation autotuning</p> <p>Comprehensive motor parameter autotune.</p>	0	©

Function code	Name	Detailed illustration of parameters	Default	Modify
		<p>It is recommended to use rotation autotuning when high control accuracy is needed.</p> <p>2: Static autotuning</p> <p>It is suitable in the cases when the motor cannot de-couple from the load. The autotuning for the motor parameter will impact the control accuracy.</p> <p>3: Static autotuning 2 (No autotuning for non-load current and mutual inductance)</p>		
P00.18	Function restore parameter	<p>0: No operation</p> <p>1: Restore the default value</p> <p>2: Clear fault records</p> <p>Note:</p> <p>The function code will restore to 0 after finishing the operation of the selected function code.</p> <p>Restoring to the default value will cancel the user password. Use this function with caution.</p>	0	⊙
P01 Group Start-up and stop control				
P01.08	Stop mode	<p>0: Decelerate to stop. After the stop command becomes valid, the inverter decelerates to reduce the output frequency during the set time. When the frequency decreases to 0Hz, the inverter stops.</p> <p>1: Coast to stop. After the stop command</p>	0	○

Function code	Name	Detailed illustration of parameters		Default	Modify
		becomes valid, the inverter ceases the output immediately. And the load coasts to stop at the mechanical inertia.			
P01.18	Operation protection	0: The terminal running command is invalid when powering on. 1: The terminal running command is valid when powering on.		1	○
P01.21	Restart after power off	0: Disabled 1: Enabled		1	○
P02 Group Motor 1 parameters					
P02.00	Motor type	0: Asynchronous motor 1: Reserved		0	◎
P02.01	Rated power of asynchronous motor	0.1–3000.0kW	Set the parameter of the asynchronous motor.	Depend on model	◎
P02.02	Rated frequency of asynchronous motor	0.01Hz–P00.03	In order to ensure the controlling performance, set the P02.01–P02.05	50.00 Hz	◎
P02.03	Rated rotating speed of asynchronous motor	1–3600rpm	according to the name plate of the asynchronous motor.	Depend on model	◎
P02.04	Rated voltage of asynchronous motor	0–1200V	GD100-PV series inverters provide the function of parameter autotuning. Correct	Depend on model	◎

Function code	Name	Detailed illustration of parameters		Default	Modify
P02.05	Rated current of asynchronous motor	0.8–6000.0A	<p>parameter autotuning comes from the correct setting of the motor name plate.</p> <p>In order to ensure the controlling performance, please configure the motor according to the standard principles, if the gap between the motor and the standard one is huge, the features of the inverter will decrease.</p> <p>Note: Resetting the rated power (P02.01) of the motor can initialize the motor parameters P02.02–P02.10.</p>	Depend on model	⊙
P02.06	Stator resistor of asynchronous motor	0.001–65.535Ω	After the motor parameter autotuning finishes, the set values	Depend on model	○
P02.07	Rotor resistor of asynchronous motor	0.001–65.535Ω	of P02.06–P02.10 will be updated	Depend on model	○
P02.08	Leakage inductance of asynchronous	0.1–6553.5mH	automatically. These parameters are basic parameters controlled	Depend on model	○

Function code	Name	Detailed illustration of parameters		Default	Modify
	motor		by vectors which		
P02.09	Mutual inductance of asynchronous motor	0.1–6553.5mH	directly impact the features. Note: Users cannot	Depend on model	○
P02.10	Non-load current of asynchronous motor	0.1–6553.5A	modify the parameters freely.	Depend on model	○
P04 Group SVPWM control					
P04.00	V/F curve setting	<p>These function codes define the V/F curve of GD100-PV series motor 1 to meet the need of different loads.</p> <p>0: Straight line V/F curve; applying to the constant torque load</p> <p>1: Multi-dots V/F curve</p> <p>2: Torque-stepdown characteristic curve (1.3 order)</p> <p>3: Torque-stepdown characteristic curve (1.7 order)</p> <p>4: Torque-stepdown characteristic curve (2.0 order)</p> <p>Curves 2–4 apply to the torque loads such as fans and water pumps. Users can adjust according to the features of the loads to get the best performance.</p> <p>5: Customized V/F(V/F separation); in this mode, V can be separated from f and f can be adjusted through the frequency given channel set by P00.06 or the voltage given channel set by P04.27 to</p>		4	◎

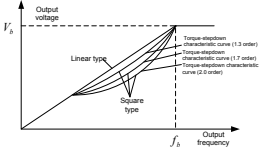
Function code	Name	Detailed illustration of parameters	Default	Modify
		<p>change the feature of the curve.</p> <p>Note: V_b in the below picture is the motor rated voltage and f_b is the motor rated frequency.</p> 		
P04.01	Torque boost	Torque boost to the output voltage for the	0.0%	<input type="radio"/>
P04.02	Torque boost close	<p>features of low frequency torque. P04.01 is for the Max. output voltage V_b. P04.02 defines the percentage of closing frequency of manual torque to f_b.</p> <p>Torque boost should be selected according to the load. The bigger the load is, the bigger the torque is. Too big torque boost is inappropriate because the motor will run with over magnetic, and the current of the inverter will increase to add the temperature of the inverter and decrease the efficiency.</p> <p>When the torque boost is set to 0.0%, the inverter is automatic torque boost.</p> <p>Torque boost threshold: below this frequency point, the torque boost is valid, but over this frequency point, the torque boost is invalid.</p>	20.0%	<input type="radio"/>

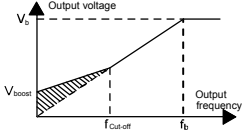
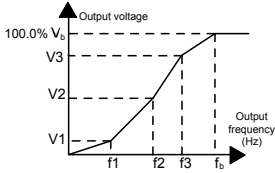
Function code	Name	Detailed illustration of parameters	Default	Modify
		 <p>Setting range of P04.01: 0.0%: (automatic) 0.1%–10.0% Setting range of P04.02: 0.0%–50.0%</p>		
P04.03	V/F frequency point 1 of motor 1	<p>If P04.00 =1, the user can set V/f curve by P04.03–P04.08. V/f is set to the motor load.</p> <p>Note: $V1 < V2 < V3$; $f1 < f2 < f3$. If the low-frequency voltage is high, overtemperature and burning may occur and the overcurrent stall and protection may occur to the inverter.</p>	0.00Hz	<input type="radio"/>
P04.04	V/F voltage point 1 of motor 1		00.0%	<input type="radio"/>
P04.05	V/F frequency point 2 of motor 1		00.00 Hz	<input type="radio"/>
P04.06	V/F voltage point 2 of motor 1		00.0%	<input type="radio"/>
P04.07	V/F frequency point 3 of motor 1	<p>Setting range of P04.03: 0.00Hz–P04.05 (rated voltage of motor1) Setting range of P04.04: 0.0%–110.0% Setting range of P04.05: P04.03–P04.07 Setting range of P04.06: 0.0%–110.0%</p>	00.00 Hz	<input type="radio"/>
P04.08	V/F voltage point 3 of motor 1	<p>Setting range of P04.07: P04.05–P02.02 (rated voltage of motor1)</p>	00.0%	<input type="radio"/>

Function code	Name	Detailed illustration of parameters	Default	Modify
		(rated frequency of motor1) or P04.05 – P02.16 (rated frequency of motor1) Setting range of P04.08 : 0.0%–110.0% (rated voltage of motor1)		
P04.09	V/F slip compensation gain	This function code is used to compensate the change of the rotation speed caused by load during compensation SVPWM control to improve the rigidity of the motor. It can be set to the rated slip frequency of the motor which is counted as below: $\Delta f = f_b - n \cdot p / 60$ Of which, f_b is the rated frequency of the motor, its function code is P02.01 ; n is the rated rotating speed of the motor and its function code is P02.02 ; p is the pole pair of the motor. 100.0% corresponds to the rated slip frequency Δf . Setting range: 0.0–200.0%	0.0%	○
P04.34	Two phase control selection of single-phase motor	Ones: Reserved Tens: Voltage of the secondary winding (V phase) reverse 0: Not reversed; 1: Reversed Setting range: 0–0x11	0x00	◎
P04.35	Voltage ratio of V and U	0.00–2.00	1.40	○
P05 Group Input terminals				
P05.00	HDI input type	0: High-speed pulse input. See P05.49 – P05.54 .	1	◎

Function code	Name	Detailed illustration of parameters	Default	Modify
		1: HDI switch input		
P05.01	S1 terminals function selection	0: No function	42	⊙
P05.02	S2 terminals function selection	1: Forward rotation operation 2: Reverse rotation operation 3: 3-wire control operation	43	⊙
P05.03	S3 terminals function selection	4: Forward jogging 5: Reverse jogging 6: Coast to stop	44	⊙
P05.04	S4 terminals function selection	7: Fault reset 8: Operation pause	45	⊙
P05.05	S5 terminals function selection	9: External fault input 10: Increasing frequency setting (UP) 11: Decreasing frequency setting (DOWN)	1	
P05.09	HDI terminals function selection	12: Cancel the frequency change setting 13: Shift between A setting and B setting 14: Shift between combination setting and A setting 15: Shift between combination setting and B setting 16: Multi-step speed terminal 1 17: Multi-step speed terminal 2 18: Multi-step speed terminal 3 19: Multi-step speed terminal 4 20: Multi-step speed pause 21: ACC/DEC time 1 22: ACC/DEC time 2 23: Simple PLC stop reset 24: Simple PLC pause	46	⊙

Function code	Name	Detailed illustration of parameters	Default	Modify
		25: PID control pause 26: Traverse pause (stop at the current frequency) 27: Traverse reset (return to the center frequency) 28: Counter reset 29: Torque control prohibition 30: ACC/DEC prohibition 31: Counter trigger 32: Reserved 33: Cancel the frequency change setting 34: DC brake 35: Reserved 36: Shift the command to the keypad 37: Shift the command to terminals 38: Shift the command to communication 39: Pre-magnetized command 40: Clear the power 41: Keep the power 42: Forced switch to power frequency input (Switching-on indicates switching to power frequency input; switching-off indicates the input mode is controlled by the keypad.) 43: Full water signal 44: Non-water signal 45: Two-phase control mode of the single-phase motor		

Function code	Name	Detailed illustration of parameters	Default	Modify										
		46: PV voltage digital input when no boost module is applied (in auto switching mode) 47–63: Reserved												
P05.10	Polarity selection of the input terminals	0x000–0x10F	0x000	⊙										
		<table border="1"> <thead> <tr> <th>BIT8</th> <th>BIT3</th> <th>BIT2</th> <th>BIT1</th> <th>BIT0</th> </tr> </thead> <tbody> <tr> <td>HDI</td> <td>S4</td> <td>S3</td> <td>S2</td> <td>S1</td> </tr> </tbody> </table>			BIT8	BIT3	BIT2	BIT1	BIT0	HDI	S4	S3	S2	S1
		BIT8			BIT3	BIT2	BIT1	BIT0						
HDI	S4	S3	S2	S1										
P06 Group Output terminals														
P06.03	Relay RO1 output selection	0: Invalid 1: In operation 2: Forward rotation operation 3: Reverse rotation operation 4: Jogging operation 5: Inverter fault 6: Frequency degree test FDT1 7: Frequency degree test FDT2 8: Frequency arrival 9: Zero speed running 10: Upper limit frequency arrival	30	○										
P06.04	Relay RO2 output selection	11: Lower limit frequency arrival 12: Ready for operation 13: Pre-magnetizing 14: Overload alarm 15: Underload alarm 16: Completion of simple PLC stage 17: Completion of simple PLC cycle 18: Setting count value arrival 19: Defined count value arrival	5	○										

Function code	Name	Detailed illustration of parameters	Default	Modify				
		20: External fault valid 21: Reserved 22: Running time arrival 23: Modbus communication virtual terminals output 24–26: Reserved 27: Weak light 28 - 29: Reserved 30: Shift to PV mode (If the system works in PV mode, relay output is high.)						
P06.05	Polarity selection of output terminals	The function code is used to set the pole of the output terminal. When the current bit is set to 0, output terminal is positive. When the current bit is set to 1, output terminal is negative. <table border="1" data-bbox="480 835 695 918"> <tr> <td>BIT1</td> <td>BIT0</td> </tr> <tr> <td>RO2</td> <td>RO1</td> </tr> </table> Setting range: 0–F	BIT1	BIT0	RO2	RO1	0	○
BIT1	BIT0							
RO2	RO1							
P06.10	Switch on delay of RO1	0.000–50.000s	10.000s	○				
P06.11	Switch off delay of RO1	0.000–50.000s	10.000s	○				
P06.12	Switch on delay of RO2	0.000–50.000s	0.000s	○				
P06.13	Switch off delay of RO2	0.000–50.000s	0.000s	○				

Function code	Name	Detailed illustration of parameters	Default	Modify
P07 Group Human-Machine Interface				
P07.02	<p>QUICK/JOG function selection</p>	<p>0: No function</p> <p>1: Jogging running. Press QUICK/JOG to begin the jogging running.</p> <p>2: Shift the display state by the shifting key. Press QUICK/JOG to shift the displayed function code from right to left.</p> <p>3: Shift between forward rotations and reverse rotations. Press QUICK/JOG to shift the direction of the frequency commands. This function is only valid in the keypad commands channels.</p> <p>4: Clear UP/DOWN settings. Press QUICK/JOG to clear the set value of UP/DOWN.</p> <p>5: Coast to stop. Press QUICK/JOG to coast to stop.</p> <p>6: Shift the running commands source. Press QUICK/JOG to shift the running commands source.</p> <p>7: Quick commissioning mode (based on non-factory parameters)</p> <p>Note: Press QUICK/JOG to shift between forward rotation and reverse rotation, the inverter does not record the state after shifting during powering off. The inverter will run according to parameter P00.13 during next powering on.</p>	6	©

Function code	Name	Detailed illustration of parameters	Default	Modify
P07.03	QUICK/JOG the shifting sequence of running command	When P07.02 =6, set the shifting sequence of running command channels. 0: Keypad control→terminal control→communication control 1: Keypad control←→terminals control 2: Keypad control←→communication control 3: Terminals control←→communication control	1	○
P07.04	STOP/RST stop function	Select the stop function by STOP/RST. STOP/RST is effective in any state for the keypad reset. 0: Only valid for the keypad control 1: Both valid for keypad and terminals control 2: Both valid for keypad and communication control 3: Valid for all control modes	1	○
P07.11	Boost module temperature	When the inverter is configured with the boost module, this function code displays the temperature of this module. This function code is valid only in the AC mode. This function code is invalid in the PV mode. -20.0–120.0°		●
P07.12	Converter module temperature	-20.0–120.0°		●
P07.15	MSB of inverter	Display the power used by the inverter.		●

Function code	Name	Detailed illustration of parameters	Default	Modify
	power consumption	Inverter power consumption = $P07.15 * 1000 + P07.16$		
P07.16	LSB of inverter power consumption	Setting range of P07.15 : 0–65535 (*1000) Setting range of P07.16 : 0.0–999.9 Unit: kWh		●
P07.27	Current fault type	0: No fault		●
P07.28	Previous fault type	1: IGBT U phase protection (OUt1) 2: IGBT V phase protection (OUt2)		●
P07.29	Previous 2 fault type	3: IGBT W phase protection (OUt3) 4: OC1		●
P07.30	Previous 3 fault type	5: OC2 6: OC3		●
P07.31	Previous 4 fault type	7: OV1 8: OV2		●
P07.32	Previous 5 fault type	9: OV3 10: UV		●
P07.57	Previous 6 fault type	11: Motor overload (OL1) 12: The inverter overload (OL2)		●
P07.58	Previous 7 fault type	13: Input side phase loss (SPI) 14: Output side phase loss (SPO)		●
P07.59	Previous 8 fault type	15: Overheat of the boost module (OH1) 16: Overheat fault of the inverter module		●
P07.60	Previous 9 fault type	(OH2) 17: External fault (EF)		●
P07.61	Previous 10 fault type	18: 485 communication fault (CE) 19: Current detection fault (ItE)		●
P07.62	Previous 11 fault type	20: Motor antotune fault (tE) 21: EEPROM operation fault (EEP)		●

Function code	Name	Detailed illustration of parameters	Default	Modify
P07.63	Previous 12 fault type	22: PID response offline fault (PIDE) 23: Braking unit fault (bCE)		●
P07.64	Previous 13 fault type	24: Running time arrival (END) 25: Electrical overload (OL3)		●
P07.65	Previous 14 fault type	26 - 31:Reserved 32: Grounding short circuit fault 1 (ETH1)		●
P07.66	Previous 15 fault type	33: Grounding short circuit fault 2 (ETH2) 34: Speed deviation fault (dEu)		●
P07.67	Previous 16 fault type	35: Maladjustment (STo) 36:Underload fault (LL)		●
P07.68	Previous 17 fault type	37: Hydraulic probe damage (tSF) 38: PV reverse connection fault (PINV)		●
P07.69	Previous 18 fault type	39: PV overcurrent (PVOC) 40: PV overvoltage (PVOV)		●
P07.70	Previous 19 fault type	41: PV undervoltage (PVLV) 42: Fault on communication with the boost		●
P07.71	Previous 20 fault type	module (E-422) 43: Bus overvoltage detected on the boost module (OV) Note: Faults 38 - 40 can be detected in boost. The boost module stops working once after detecting a fault. The boost module sends back the fault information to the inverter module in the next data send back. Alarms: Weak light alarm (A-LS) Underload alarm (A-LL)		●

Function code	Name	Detailed illustration of parameters	Default	Modify
		Full water alarm (A-tF) Water-empty alarm (A-tL)		
P08 Group Enhanced functions				
P08.28	Times of fault reset	0–10	5	○
P08.29	Interval time of automatic fault reset	0.1–3600.0s	10.0s	○

6.2 Parameters of special functions

Function code	Name	Detailed illustration of parameters	Default	Modify
P11 Group Protective parameters				
P11.00	Phase loss protection	0x000–0x011 LED ones: 0: Input phase loss software protection disabled 1: Input phase loss software protection enabled LED tens: 0: Output phase loss software protection disabled 1: Output phase loss software protection enabled LED hundreds: Reserved 000–111	Depend on model	○
P11.01	Frequency decrease at	0: Disable 1: Enable	0	○

Function code	Name	Detailed illustration of parameters	Default	Modify						
	sudden power loss									
P11.02	Frequency decrease ratio at sudden power loss	<p>Setting range: 0.00Hz–P00.03/s</p> <p>After the power loss of the grid, the bus voltage drops to the sudden frequency decrease point, the inverter begin to decrease the running frequency at P11.02, to make the inverter generate power again. The returning power can maintain the bus voltage to ensure a rated running of the inverter until the recovery of power.</p> <table border="1"> <tr> <td>Voltage degree</td> <td>220V</td> <td>400V</td> </tr> <tr> <td>Frequency decrease point</td> <td>260V</td> <td>460V</td> </tr> </table>	Voltage degree	220V	400V	Frequency decrease point	260V	460V	0.00Hz/s	○
Voltage degree	220V	400V								
Frequency decrease point	260V	460V								
P15 Group Special functions for PV inverters										
P15.00	PV inverter selection	<p>0: Invalid</p> <p>1: Enable</p> <p>0 means the function is invalid and the group of parameters cannot be used</p> <p>1 means the function is enabled, and P15 parameters can be adjusted</p>	1	◎						
P15.01	Vmpp voltage reference	<p>0: Voltage reference</p> <p>1: Max. power tracking</p> <p>0 means to apply voltage reference mode. The reference is a fixed value and given by P15.02.</p> <p>1 means to apply the reference voltage of Max. power tracking. The voltage is</p>	1	◎						

Function code	Name	Detailed illustration of parameters	Default	Modify
		changing until the system is stable. Note: If terminal 43 is valid, the function is invalid.		
P15.02	Vmpp voltage keypad reference	0.0–6553.5 V DC If P15.01 is 0, the reference voltage is given by P15.02 . (During test, reference voltage should be lower than PV input voltage; otherwise, the system will run at lower limit of frequency).	250.0V	○
P15.03	PI control deviation	0.0–100.0% (100.0% corresponds to P15.02) If the ratio percentage of real voltage to reference voltage, which is $\text{abs}(\text{bus voltage} - \text{reference voltage}) * 100.0\% / \text{reference voltage}$, exceeds the deviation limit of P15.03 , PI adjustment is available; otherwise, there is no PI adjustment and the value is defaulted to be 0.0%. abs: absolute value	0.0%	○
P15.04	Upper frequency of PI output	P15.05 –100.0% (100.0% corresponds to P00.03) P15.04 is used to limit the Max. value of target frequency, and 100.0% corresponds to P00.03 . After PI adjustment, the target frequency cannot exceed the upper limit.	100.0%	○
P15.05	Lower frequency	0.0%– P15.04 (100.0% corresponds to	20.0%	○

Function code	Name	Detailed illustration of parameters	Default	Modify
	of PI output	P00.03) P15.05 is used to limit the Min. value of target frequency, and 100.0% corresponds to P00.03 . After PI adjustment, the target frequency cannot be less than the lower limit.		
P15.06	KP1	0.00–100.00 Proportion coefficient 1 of the target frequency The bigger the value is, the stronger the effect and faster the adjustment is.	5.00	○
P15.07	KI1	0.00–100.00 Integral coefficient 1 of the target frequency The bigger the value is, the stronger the effect and faster the adjustment is.	5.00	○
P15.08	KP2	0.00–100.00 Proportion coefficient 2 of the target frequency The bigger the value is, the stronger the effect and faster the adjustment is.	35.00	○
P15.09	KI2	0.00–100.00 Integral coefficient 2 of the target frequency The bigger the value is, the stronger the effect and faster the adjustment is.	35.00	○
P15.10	PI switching point	0.0–6553.5Vdc If the absolute value of bus voltage	20.0V	◎

Function code	Name	Detailed illustration of parameters	Default	Modify
		<p>minus the reference value is bigger than P15.10, it will switch to P15.08 and P15.09; otherwise it is P15.06 and P15.07.</p>		
P15.11	Water level control	<p>0: Digital input of the water-level control 1: AI1(the water-level signal is input through AI1, not supported currently) 2: AI2 (the water-level signal is input through AI2, not supported currently) 3: AI3 (the water-level signal is input through AI3, not supported currently)</p> <p>If the function code is 0, the water-level signal is controlled by the digital input. See 43 and 44 functions of S terminals in group P05 for detailed information. If the full-water signal is valid, the system will report the alarm (A-tF) and sleep after the time of P15.14. During the alarm, the full-water signal is invalid and the system will clear the alarm after the time of P15.15. If the empty-water signal is valid, the system will report the alarm (A-tL) and sleep after the time of P15.16. During the alarm, the empty -water signal is invalid and the system will clear the alarm after the time of P15.17.</p> <p>If the function code is 1 - 3, it is the reference of water-level control analog</p>	0	⊙

Function code	Name	Detailed illustration of parameters	Default	Modify
		signal. For details, see P15.12 and P12.13 .		
P15.12	Full-water level threshold	<p>0.0–100.0%</p> <p>This code is valid when P15.11 water level control is based on analog input. If the detected water level control analog signal is less than the water level threshold P15.12 and keeps in the state after the delay time P15.14, the system reports A-tF and sleeps.</p> <p>If the delay time is not reached, the signal is bigger than the water level threshold, the time will be cleared automatically. When the measured water level control analog signal is less than the water level threshold, the delay time will be counted again.</p> <p>0 is full water and 1 is no water.</p> <p>During the full-water alarm, if the detected water level signal is higher than the threshold of P15.12 and the delay counts, the alarm is cleared after the time set by P15.15 is reached in this continuous state continues. During the non-continuous application, the delay timing will clear automatically.</p>	25.0%	○
P15.13	Empty-water level threshold	<p>0.0–100.0%</p> <p>This code is valid when P15.11 water</p>	75.0%	○

Function code	Name	Detailed illustration of parameters	Default	Modify
		<p>level control is based on analog input.</p> <p>If the detected water level control analog signal is greater than the water level threshold P15.13 and keeps in the state after the delay time P15.16, the system reports A- tL and sleeps. If the delay time is not reached (that means non-continuous), the delay time is automatically cleared. When the detected water level control analog signal is less than the water level threshold, the delay counts.</p> <p>During the empty-water alarm, if the detected water level control analog signal is less than the water level threshold P15.13 and delay counts, the empty-water alarm is cleared after the delay time set by P15.17 in this continuous state. In the non-continuous state, the delay time is automatically cleared.</p>		
P15.14	Full water delay	0–10000s Time setting of full water delay (This function code is still valid when the digital indicates the full-water signal.)	5s	○
P15.15	Wake-up delay in full water state	0–10000s Time setting of wake-up delay in full-water state (This function code is still	20s	○

Function code	Name	Detailed illustration of parameters	Default	Modify
		valid when the digital indicates the full-water signal.)		
P15.16	Empty-water delay	0–10000s Time setting of empty-water delay (This function code is still valid when the digital indicates the empty-water signal.)	5s	○
P15.17	Wake-up delay in empty-water state	0–10000s Time setting of wake-up delay in empty-water state (This function code is still valid when the digital indicates the empty-water signal.)	20s	○
P15.18	Hydraulic probe damage	0.0–100.0% 0.0%: Invalid. If it is not 0.0%, when the signal is longer than P15.18 , it will report tSF fault directly and stop.	0.0%	◎
P15.19	Operation time of water pump underload	0.0–1000.0s This parameter is used to set the operation time of water pump underload. Under the continuous underload operation, underload prealarm (A-LL) will be reported if the operation time is reached.	60.0s	○
P15.20	Current detection value of underload operation	0.0%: Automatic underload detection 0.1–100.0% If it is 0.0%, it is determined by the underload detection of the water pump inverter. If it is not 0.0%, it is determined by	00.00%	○

Function code	Name	Detailed illustration of parameters	Default	Modify
		<p>P15.20. 100.0% corresponds to the rated current of the motor.</p> <p>If the target frequency and the absolute value of the ramp frequency is less than or equal to P15.22, and the current is less than P15.20, after the time set by P15.19, underload fault is reported. Otherwise, it will be operated normally. If the state is not continuous, the delay counting will be cleared automatically.</p>		
P15.21	Underload reset delay	<p>0.0–1000.0s</p> <p>This parameter is used to set the underload reset delay.</p> <p>The operation time and reset time are counted at the same time during underload, and it is generally bigger than P15.19 so as to ensure underload prealarm is reported after underload delay operation time is reached. After the time set by P15.21-P15.19, it is reset. If the value is the same as P15.19, it is automatically reset when underload prealarm is reported.</p>	120.0s	<input type="radio"/>
P15.22	Lag frequency threshold	<p>0.00–200.00Hz</p> <p>P15.22 is the lag frequency threshold for the analysis of underload operation. If the target frequency and the absolute value of the ramp frequency is less than</p>	0.30Hz	<input type="radio"/>

Function code	Name	Detailed illustration of parameters	Default	Modify
		or equal to P15.22 , the current will be compared.		
P15.23	Delay time of weak light	<p>0.0–3600.0s</p> <p>Delay time of weak light</p> <p>If the output frequency is less than or equal to the lower limit of PI output frequency and the state lasts for the set value, it will report A-LS and sleep. If the state is not continuous, the delay counting will be cleared automatically.</p> <p>Note: If the bus voltage is lower than the undervoltage point or the PV voltage is lower than 70V, it will report the weak light alarm without any delay time.</p> <p>If P15.32=0, the system will switch to the power frequency input when the light is weak.</p>	100.0s	○
P15.24	Delay time of wake-up at weak light	<p>0.0–3600.0s</p> <p>Delay time of wake-up at weak light</p> <p>If the weak light alarm is reported, after the delay time of wake-up, the alarm will be cleared and it will run again.</p> <p>When P15.32=0, if the PV voltage is higher than P15.34, after the delay time, it will switch to PV input mode.</p>	300.0s	○
P15.25	Initial reference voltage display	0.0–2000.0V	0	●
P15.26	Min. voltage	0.00 – 1.00	0.70	○

Function code	Name	Detailed illustration of parameters	Default	Modify															
	reference during max. power tracking	<p>This function code is used to set the minimum voltage reference during maximum power tracking. Min. voltage reference during max. power tracking = Solar cell panel open-circuit voltage * P15.26. Solar cell panel open-circuit voltage = P15.25+ P15.28</p> <p>Track the maximum power in the range of Min. voltage reference–P15.27. P15.27 must be greater than Min. voltage reference. The less the difference, the faster the tracking is. The maximum voltage needs to be in the range. P15.26 and P15.27 can be adjusted according to site operation.</p>																	
P15.27	Max. voltage reference during max. power tracking	<p>Min. voltage reference during max. power tracking–P15.31</p> <p>Valid in MPPT Max. tracking voltage, the tracked max. voltage</p> <p>The default value depends on model.</p> <table border="1"> <thead> <tr> <th>Model</th> <th>Max. voltage reference</th> <th>Max. Vmppt</th> </tr> </thead> <tbody> <tr> <td>-SS2</td> <td>400</td> <td>400</td> </tr> <tr> <td>-S2</td> <td>400</td> <td>400</td> </tr> <tr> <td>-2</td> <td>400</td> <td>400</td> </tr> <tr> <td>-4</td> <td>750</td> <td>750</td> </tr> </tbody> </table>	Model	Max. voltage reference	Max. Vmppt	-SS2	400	400	-S2	400	400	-2	400	400	-4	750	750	400.0V	○
Model	Max. voltage reference	Max. Vmppt																	
-SS2	400	400																	
-S2	400	400																	
-2	400	400																	
-4	750	750																	
P15.28	Adjustment of initial reference voltage	<p>0.0–200.0V</p> <p>MPPT begins to change from the reference voltage</p>	5.0V	○															

Function code	Name	Detailed illustration of parameters	Default	Modify
		Initial reference voltage =PV voltage- P15.28		
P15.29	Adjustment of upper and lower limit time of Vmppt	<p>0.0–10.0s</p> <p>When P15.29 is set to 0.0, the automatic adjustment is invalid.</p> <p>If it is not 0.0, the upper and lower limits of Vmppt will be adjusted automatically at the interval set by P15.29. The medium value is the current PV voltage and the limit is P15.30:</p> <p>Maximum/Minimum reference voltage=Current PV voltage±P15.30 and it will update to P15.26 and P15.27 at the same time.</p>	1.0s	○
P15.30	Adjustment of upper and lower limits of Vmppt	<p>5.0–100.0V</p> <p>Adjustment of the upper and lower limits</p>	30.0V	○
P15.31	Max. value of Vmppt	<p>P15.27–6553.5V</p> <p>During the maximum power tracking, the upper limit of the solar cell panel reference voltage will not exceed the value set by P15.31. The factory value depends on the model. By default, the value for the -4 models is 750V and the value for other models is 400V.</p>	400.0V	○
P15.32	PV input and power frequency input selection	<p>0: Automatic shift</p> <p>1: Power frequency input</p> <p>2: PV input</p>	2	◎

Function code	Name	Detailed illustration of parameters	Default	Modify
		<p>If the value is 0, the system will switch between PV input and power frequency input according to the detected PV voltage and threshold;</p> <p>If the value is 1, the system will force to switch to power frequency input;</p> <p>If the value is 2, the system will force to switch to PV input.</p> <p>Note: When the terminal input 42 is valid, the function code will be invalid.</p>		
P15.33	Threshold to switch to power frequency input	<p>0.0V–P15.34</p> <p>If PV voltage is lower than the threshold or the light is weak, it can switch to power frequency input through the relay output.</p> <p>If the value is 0, it is invalid.</p> <p>For inverters without the boost module, the switching point voltage is determined by the external voltage detection circuit.</p> <p>For inverters with the boost module, the switching point voltage is 70V.</p>	70.0V	○
P15.34	Threshold to switch to PV input	<p>P15.33–400.0V</p> <p>If PV voltage is greater than the threshold, it can switch to PV input through the relay output after the time set by P15.24. To prevent frequent switching, this threshold must be greater than P15.33.</p>	100.0V	○

Function code	Name	Detailed illustration of parameters	Default	Modify												
		If the value is 0.0, it is invalid. The default value depends on model.														
P15.35	Rated pump flow	The pump flow is Q_N if the pump runs at the rated pump frequency and rated lift. Unit: cubic meter/hour.	0.0	○												
P15.36	Rated pump lift	The pump lift is H_N if the pump runs at the rated frequency and rated current. Unit: meter	0.0	○												
P15.37	Voltage setting at PV undervoltage point	<p>When the PV voltage is less than the preset voltage, the system reports the PV undervoltage (UV) fault. The default value depends on the model.</p> <table border="1"> <thead> <tr> <th>Model</th> <th>PV UV point</th> </tr> </thead> <tbody> <tr> <td>-SS2</td> <td>140V</td> </tr> <tr> <td>-S2</td> <td>140V</td> </tr> <tr> <td>-2</td> <td>140V</td> </tr> <tr> <td>-4</td> <td>240V</td> </tr> <tr> <td>Any model with the boost module</td> <td>70V</td> </tr> </tbody> </table> <p>Setting range: 0.0–400.0</p>	Model	PV UV point	-SS2	140V	-S2	140V	-2	140V	-4	240V	Any model with the boost module	70V	70.0	○
Model	PV UV point															
-SS2	140V															
-S2	140V															
-2	140V															
-4	240V															
Any model with the boost module	70V															
P15.39	Model	<p>This function code is provided for users to change models. For example, if the user wants to use model -4 (default after factory delivery) as model -2, P15.39 must be set to 2.</p> <p>0: -SS2 220V; single-phase input; single-phase output</p>	0	◎												

Function code	Name	Detailed illustration of parameters	Default	Modify
		1: -S2 220V; single-phase input; three-phase output 2: -2 220V; three-phase input; three-phase output 3: -4 380V; three-phase input; three-phase output Setting range: 0–3		
P17 Group State viewing				
P17.38	Current of the main winding	It is the current of the main winding when applying capacitance-removing to control the single phase motor. 0.00–100.00A	0.0A	●
P17.39	Current of the secondary winding	It is the current of the secondary winding when applying capacitance-removing to control the single phase motor. 0.00–100.00A	0.0A	●
P18 Group State viewing special for solar converters				
P18.00	PV reference voltage	MPPT is implemented at the converter side. This value is determined at the converter side.		●
P18.01	Current PV voltage	It is transferred from the boost module or equal to the bus voltage.		●
P18.02	Display of MPPT min. reference voltage	The value displays the minimum voltage reference during maximum power tracking. It equals the solar cell panel open-circuit voltage multiplied P15.26 .		●
P18.04	Current inductive current	It is transferred from the boost module. This function code is valid only in AC		●

Function code	Name	Detailed illustration of parameters	Default	Modify
		mode and invalid in PV mode.		
P18.07	PV input power	Reserved. Unit: kW		●
P18.08	Previous PV input power	Reserved		●
P18.09	Previous PV voltage	Reserved		●
P18.10	Device configuration display	0x00–0x11 Ones on LED 0: PV power supply 1: AC grid power supply Tens on LED 0: Detection indicates the system contains the boost module. 1: Detection indicates the system does not contain the boost module.		●
P18.11	Current pump flow	Unit: cubic meter/hour	0.0	●
P18.12	Current pump lift	Unit: meter	0.0	●
P18.13	MSBs in total pump flow	This function code displays the 16 most significant bits (MSBs) in the total pump flow. Unit: cubic meter	0	●
P18.14	LSBs in total pump flow	This function code displays the 16 least significant bits (LSBs) in the total pump flow. Unit: cubic meter. Total pump flow = P18.13 *65535 + P18.14	0.0	●
P18.15	Total pump flow resetting	Setting this value to 1 can reset the total pump flow. P18.13 and P18.14 will accumulate the flow after resetting. After the resetting succeeds, P18.15 is	0	◎

Function code	Name	Detailed illustration of parameters	Default	Modify
		automatically set to 0.		
P19 Group Voltage boost (converter module communicates with boost module through 485)				
P19.00	Boost voltage loop KP	0.000–65.535	0.500	○
P19.01	Boost voltage loop KI	0.000–65.535	0.080	○
P19.02	Boost current loop KP	0.000–65.535	0.010	○
P19.03	Boost current loop KI	0.000–65.535	0.010	○
P19.04	Upper limit of the output current of boost voltage loop PI	Upper limit output of mppt voltage loop PI, upper limit of the boost current loop reference current P19.05–15.0A	12.0A	○
P19.06	Bus reference voltage	This function code is set to the bus reference voltage at PV input when the system contains the boost module. By default, this function code is set to 350V for models of 220V and 570V for models of 380V. Setting range: 300.0V–600.0V	350.0V	◎
P19.07	Boost voltage loop KP1	If the difference between the bus reference voltage and actual bus voltage is greater than 20V, the boost voltage loop uses this group PI parameter. Otherwise, the boost voltage loop uses the first group PI parameter. Setting range: 0.000–65.535	0.500	○

Function code	Name	Detailed illustration of parameters	Default	Modify
P19.08	Boost voltage loop KI1	If the difference between the bus reference voltage and actual bus voltage is greater than 20V, the boost voltage loop uses the PI parameters of this group. Otherwise, the boost voltage loop uses the PI parameters of the first group. Setting range: 0.000–65.535	0.080	○
P19.10	Boost software version	Once being powered, the boost module sends its version information to the converter module.	0.00	●

Note:

- The time when the pump inverter operated to the lower limit of PI output frequency after inverter start-up is determined by the ACC time.
- Delay time counting follows the rules if multiple fault conditions are met simultaneously: For example, if all fault conditions of weak light, full water, and underload are met at the same time, the inverter will count the delay time for each fault independently. If the delay time of a fault is reached, the fault is reported. The delay time counting of the other two faults keeps. If the reported fault is resolved but the conditions of the other two faults persist, the delay time counting of the other two faults continues. If a fault condition is not met during counting, the delay time of this fault is cleared.

7 Fault diagnosis and solution

Do as follows after the inverter encounters a fault:

1. Check to ensure there is nothing wrong with the keypad. If not, please contact with the local INVT office.
2. If there is nothing wrong, please check P07 and ensure the corresponding recorded fault parameters to confirm the real state when the current fault occurs by all parameters.
3. See the following table for detailed solution and check the corresponding abnormal state.
4. Eliminate the fault and ask for relative help.
5. Check to eliminate the fault and carry out fault reset to run the inverter.

Fault code	Fault type	Possible cause	Solutions
OUt1	IGBT U	1. The acceleration is too fast. 2. This phase IGBT is damaged internally.	1. Increase the acceleration time.
OUt2	IGBT V		
OUt3	IGBT W	3. Interference causes misoperation. 4. The drive wire is connected improperly. 5. The load transients or is abnormal. 6. The grounding is short circuited.	2. Change the power unit. 3. Check the drive wire. 4. Check whether the peripheral equipment has strong interference sources.
OV1	Overvoltage when acceleration	1. The input voltage is abnormal. 2. There is large energy feedback. 3. No braking components. 4. Braking energy is not open.	1. Check the input power. 2. Check if the DEC time of the load is too short or the inverter starts during the rotation of the motor or it needs to increase the energy consumption components. 3. Install the braking components. 4. Check the setting of relative function codes.
OV2	Overvoltage when deceleration		
OV3	Overvoltage when constant speed running		
OC1	Overcurrent when acceleration	1. The acceleration or deceleration is too fast. 2. The voltage of the grid is too low. 3. The power of the inverter is	1. Increase the ACC time. 2. Check the input power. 3. Select the inverter with a larger power. 4. Check if the load is short
OC2	Overcurrent when deceleration		

Fault code	Fault type	Possible cause	Solutions
OC3	Overcurrent when constant speed running	too low. 4. The load transients or is abnormal. 5. The grounding is short circuited or the output is phase loss. 6. There is strong external interference. 7. The overvoltage stall protection is not open.	circuited (the grounding short circuited or the wire short circuited) or the rotation is not smooth. 5. Check the output configuration. 6. Check if there is strong interference. 7. Check the setting of relative function codes.
UV	Bus undervoltage	1. The voltage of the power supply is too low. 2. The overvoltage stall protection is not open.	1. Check the input power of the supply line. 2. Check the setting of relative function codes.
OL1	Motor overload	1. The voltage of the power supply is too low. 2. The motor setting rated current is incorrect. 3. The motor stall or load transients is too strong.	1. Check the power of the supply line. 2. Reset the rated current of the motor. 3. Check the load and adjust the torque lift.
OL2	Inverter overload	1. The acceleration is too fast. 2. The rotating motor is reset. 3. The voltage of the power supply is too low. 4. The load is too heavy. 5. The motor power is too small.	1. Increase the ACC time. 2. Avoid the restarting after stopping. 3. Check the power of the supply line. 4. Select an inverter with bigger power. 5. Select a proper motor.
SPI	Input phase loss	Phase loss or fluctuation of input R,S,T	1. Check input power. 2. Check installation distribution.
SPO	Output phase loss	U,V,W phase loss output (or serious asymmetrical three phase of the load)	1. Check the output distribution. 2. Check the motor and cable.
OH1	Rectifier overheat	1. Air duct jam or fan damage	1. Dredge the wind channel or

Fault code	Fault type	Possible cause	Solutions
OH2	IGBT overheat	2. Ambient temperature is too high. 3. The time of overload running is too long.	change the fan. 2. Decrease the environment temperature.
EF	External fault	SI external fault input terminals action	Check the external device input.
CE	Communication error	1. The baud rate setting is incorrect. 2. Fault occurs to the communication wiring. 3. The communication address is wrong. 4. There is strong interference to the communication.	1. Set proper baud rate. 2. Check the communication connection distribution 3. Set proper communication address. 4. Change or replace the connection distribution or improve the anti-interference capability.
ItE	Current detection fault	1. The connection of the control board is not good. 2. Assistant power is bad 3. Hall components is broken 4. The magnifying circuit is abnormal.	1. Check the connector and repatch. 2. Change the Hall. 3. Change the main control panel.
tE	Autotuning fault	1. The motor capacity does not comply with the inverter capability. 2. The rated parameter of the motor is not set correctly. 3. The offset between the parameters from autotune and the standard parameter is huge 4. Autotune overtime	1. Change the inverter mode. 2. Set the rated parameter according to the motor name plate. 3. Empty the motor load. 4. Check the motor connection and set the parameter. 5. Check if the upper limit frequency is above 2/3 of the rated frequency.
EEP	EEPROM fault	1. Error of controlling the write and read of the parameters 2. Damage to EEPROM	1. Press STOP/RST to reset. 2. Change the main control panel.
PIDE	PID feedback fault	1. PID feedback is offline.	1. Check the PID feedback

Fault code	Fault type	Possible cause	Solutions
		2. The PID feedback source disappears.	signal 2. Check the PID feedback source.
END	Time arrival of factory setting	The actual running time of the inverter is above the internal setting running time.	Ask for the supplier and adjust the setting running time.
OL3	Electrical overload	The inverter will report overload pre-alarm according to the set value.	Check the load and the overload pre-alarm point.
ETH1	Grounding short circuit fault 1	The grounding of the inverter output terminal is short circuited. The current detection circuit is faulty. The actual motor power sharply differs from the inverter power.	Check whether the motor wiring is proper. Change the Hall. Change the main control panel. Set motor parameters correctly.
ETH2	Grounding short circuit fault 2		
dEu	Velocity deviation fault	The load is too heavy or stalled.	1. Check the load and ensure it is normal. Increase the detection time. 2. Check whether the control parameters are normal.
STo	Maladjustment fault	1. The control parameters of the synchronous motors not set properly. 2. The autotuning parameter is not correct. 3. The inverter is not connected to the motor.	1. Check the load and ensure it is normal. 2. Check whether the control parameter is set properly or not. 3. Increase the maladjustment detection time.
LL	Electronic underload fault	The inverter will report the underload pre-alarm according to the set value.	Check the load and the underload pre-alarm point.
tSF	Hydraulic probe	Hydraulic probe damage	Change the damaged hydraulic

Fault code	Fault type	Possible cause	Solutions
	damage		probe.
PINV	PV reverse connection fault	Incorrect PV wiring	Change the wiring direction of the positive and negative terminals and connect the cables again.
PVOC	PV overcurrent	<ol style="list-style-type: none"> 1. The acceleration or deceleration is too fast. 2. The inverter power is too low. 3. The load transients or is abnormal. 4. The grounding is short circuited. 	<ol style="list-style-type: none"> 1. Increase the ACC or DCC time. 2. Select the inverter with a larger power. 3. Check if the load is short circuited (the grounding short circuited or the wire short circuited) or the rotation is not smooth.
PVOV	PV overvoltage	<ol style="list-style-type: none"> 1. The solar cell panel input voltage is too high. 2. Model -4 is set as another model. 	<ol style="list-style-type: none"> 1. Reduce the number of solar cell panels that are wired in series. 2. Check and reset the model.
PVLV	PV undervoltage	<ol style="list-style-type: none"> 1. The power of the solar cell panel series is too low or it is cloudy and rainy weather. 2. The motor start-up current is too high. 	<ol style="list-style-type: none"> 1. Increase the number of solar cell panels or perform the test in the normal sun light. 2. Change the motor.
E-422	Fault on communication with boost module 422	Improper contact with the communication cables	Check the four communication cables of 422 and ensure that they are connected properly.
OV	Bus overvoltage detected at the boost module side	The sun light changes suddenly.	Adjust the boost PI parameters. Enlarge the values of P19.07 and P19.08.
A-LS	Weak light alarm	The sun light is weak or the solar cell panel configuration is insufficient.	The equipment automatically runs when the light becomes strong.

Fault code	Fault type	Possible cause	Solutions
			Check whether the solar cell panel configuration is proper.
A-LL	Underload alarm	The reservoir is empty.	Check the reservoir.
A-tF	Full-water alarm	The reservoir is full.	If the user has set the full-water alarm function, the equipment automatically stops when the full-water alarm time reaches the specified time. In this situation, the user does not need to perform any operation. Otherwise, check whether terminals are wired incorrectly.
A-tL	Empty-water alarm	The reservoir is empty.	If the user has set the empty-water alarm function, the equipment automatically stops when the empty-water alarm time reaches the specified time. In this situation, the user does not need to perform any operation. Otherwise, check whether terminals are wired incorrectly.

Appendix A Options and use

A.1 Boost module

The pumping inverters $\leq 2.2\text{KW}$ support the installation of the boost module (PP100-3R2-PV) to improve the utilization of the solar modules. The figure below shows the wiring method.

1. Connect PV+ and PV- of the boost module to the positive input terminal and negative input terminal of the modules respectively.
2. Connect the output terminals (+) and (-) of the boost module to the input terminals (+) and (-) of the pumping inverter.
3. Connect 422-communication receiving terminal RX of the boost module to 422-communication sending terminal TX of the pumping inverter. Connect 422-communication sending terminal TX of the boost module to 422-communication receiving terminal RX of the pumping inverter. Use twisted pairs for wiring.
4. If the wiring is connected, switch on the breaker Q1 at the DC side for automotive running.

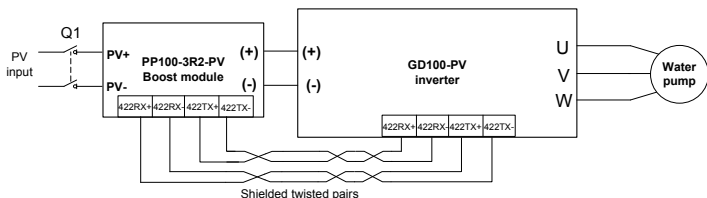

Figure A-1 Connection between the boost module and inverter

Boost module specifications

Model	PP100-3R2-PV
Input	
Max. input power (W)	3200
Max. DC voltage (V)	600
Start-up voltage (V)	80
Min. working voltage (V)	70
Max. input current (A)	12
Output	
Output voltage (V)	350/570 (automatically determined by the pumping inverter)

Instruction of LEDs

Display state	Description
Green LED flickering	The boost module has been powered on, and the control circuit is working.
Green LED on	The boost module is running.
Red LED on	The boost module is faulty.

The figure below shows the installation dimensions of the boost module.

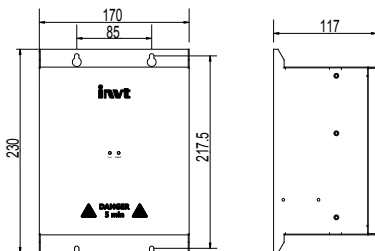

A.2 GPRS module and monitoring APP

The pumping inverters support the installation of the GPRS module to implement remote monitoring. The GPRS module connects to the inverters through 485 communication. The inverter operation state can be monitored on the APP in the mobile phone or web page in real time.

Method for connecting the GPRS to the inverter:

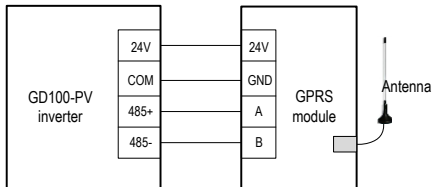

Figure A-2 Connecting the GPRS module to the inverter

For more information, see the GPRS/GPS adaptor operation guide matching the GPRS module or contact the local INVT office. When consulting, provide the product models and serial numbers.

A.3 Cables

A.3.1 Power cables

Dimension the input power and motor cables according to local regulations.

Note: A separate PE conductor is required if the conductivity of the cable shield is not sufficient for the purpose.

A.3.2 Control cables

The relay cable needs the cable type with braided metallic screen.

Keypads need to be connected with network cables. The network cables must be shielded in complicated electromagnetic environments.

Communication cables must be shielded twisted pairs.

Note:

- Run analog and digital signals in separate cables.
- Check the insulation of the input power cable according to local regulations before connecting to the drive.

Recommended power cables for standard inverter models

Model	Recommended cable size (mm ²)		Terminal screw	Tightening torque (Nm)
	(+)/(-), R/S/T, U/V/W	PE		
GD100-0R4G-S2-PV	1.5	1.5	M4	0.8
GD100-0R7G-S2-PV	1.5	1.5	M4	0.8
GD100-0R4G-SS2-PV	1.5	1.5	M4	0.8
GD100-0R7G-4-PV	1.5	1.5	M4	0.8
GD100-1R5G-4-PV	1.5	1.5	M4	0.8
GD100-2R2G-4-PV	1.5	1.5	M4	0.8
GD100-1R5G-S2-PV	2.5	2.5	M4	0.8
GD100-2R2G-S2-PV	2.5	2.5	M4	0.8
GD100-0R7G-SS2-PV	2.5	2.5	M4	0.8
GD100-1R5G-SS2-PV	2.5	2.5	M4	0.8
GD100-2R2G-SS2-PV	2.5	2.5	M4	0.8
GD100-004G-4-PV	2.5	2.5	M4	1.2–1.5
GD100-5R5G-4-PV	2.5	2.5	M4	1.2–1.5
GD100-1R5G-2-PV	2.5	2.5	M4	1.2–1.5
GD100-2R2G-2-PV	2.5	2.5	M4	1.2–1.5

Model	Recommended cable size (mm ²)		Terminal screw	Tightening torque (Nm)
	(+)/(-), R/S/T, U/V/W	PE		
GD100-7R5G-4-PV	4	4	M5	2–2.5
GD100-004G-2-PV	4	4	M5	2–2.5
GD100-011G-4-PV	6	6	M5	2–2.5
GD100-5R5G-2-PV	6	6	M5	2–2.5
GD100-015G-4-PV	10	10	M5	2–2.5
GD100-7R5G-2-PV	10	10	M5	2–2.5
GD100-018G-4-PV	16	16	M5	2–2.5
GD100-022G-4-PV	25	16	M5	2–2.5
GD100-030G-4-PV	25	16	M6	4–6
GD100-037G-4-PV	35	16	M6	4–6
GD100-045G-4-PV	35	16	M8	10
GD100-055G-4-PV	50	25	M8	10
GD100-075G-4-PV	70	35	M8	10
GD100-090G-4-PV	95	50	M12	31–40
GD100-110G-4-PV	120	70	M12	31–40
GD100-132G-4-PV	185	95	M12	31–40
GD100-160G-4-PV	240	95	M12	31–40
GD100-185G-4-PV	120*2P	150	M12	31–40
GD100-200G-4-PV	120*2P	150	M12	31–40

Note:

For the cable selection for model IP54, see the cables applicable to the models with the same power as model IP54 in this table.

It is appropriate to use the recommended cable size under 40°C and rated current. The wiring distance should be no more than 100m.

If the control cable and power cable must cross, the angle between them must be 90°.

If the inside of the inverter is moist, the insulation resistance will decrease. If there is moisture in the inverter, dry up the inverter and measure the humidity again.

A.4 Reactors

When the distance between the inverter and motor is longer than 50 m, the parasitic capacitance between the long cable and ground may cause large leakage current, and overcurrent protection of the inverter may be frequently triggered. To prevent this from happening and avoid damage to the motor insulator, compensation must be made by adding an output reactor. When an inverter is used to drive multiple motors, take the total length of the motor cables (that is, sum of the lengths of the motor cables) into account. When the total length is longer than 50 m, an output reactor must be added on the output side of the inverter. If the distance between the inverter and motor is 50 m to 100 m, select the reactor according to the following table. If the distance is longer than 100 m, contact INVT's technical support technicians.

Output reactor model selection

Inverter power	Output reactor
GD100-1R5G-2-PV	OCL2-004-4
GD100-2R2G-2-PV	OCL2-004-4
GD100-004G-2-PV	OCL2-5R5-4
GD100-5R5G-2-PV	OCL2-7R5-4
GD100-7R5G-2-PV	OCL2-015-4
GD100-0R7G-4-PV	OCL2-1R5-4
GD100-1R5G-4-PV	OCL2-1R5-4
GD100-2R2G-4-PV	OCL2-2R2-4
GD100-004G-4-PV	OCL2-004-4
GD100-5R5G-4-PV	OCL2-5R5-4
GD100-7R5G-4-PV	OCL2-7R5-4
GD100-011G-4-PV	OCL2-011-4
GD100-015G-4-PV	OCL2-015-4
GD100-018G-4-PV	OCL2-018-4
GD100-022G-4-PV	OCL2-022-4
GD100-030G-4-PV	OCL2-037-4
GD100-037G-4-PV	OCL2-037-4
GD100-045G-4-PV	OCL2-045-4
GD100-055G-4-PV	OCL2-055-4
GD100-075G-4-PV	OCL2-075-4

Inverter power	Output reactor
GD100-090G-4-PV	OCL2-110-4
GD100-110G-4-PV	OCL2-110-4
GD100-132G-4-PV	OCL2-160-4
GD100-160G-4-PV	OCL2-200-4
GD100-185G-4-PV	OCL2-200-4
GD100-200G-4-PV	OCL2-200-4

Note:

The rated derate voltage of the output reactor is $1\% \pm 15\%$.

Above options are external, and the customer should specify the model when purchasing.

A.5 Filters

C3 filters are built in GD100-PV series inverters with rated power of equal to or greater than 4kW. Jumper J10 determines the connection.

Connection method: Open the lower cover, find the location of J10, and insert the jumper terminals equipped with the inverter.

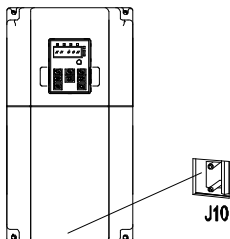

Note: After the filter is added, EMI input meets requirements for level C3.

Appendix B Recommended solar modules

B.1 Recommended configuration for solar pumping inverters

Solar pumping inverter model	Open-circuit voltage degree of solar module			
	37±1V		45±1V	
	Module power±5Wp	Modules per string * strings	Module power±5Wp	Modules per string * strings
GD100-0R4G-SS2-PV	250	11*1	300	9*1
GD100-0R7G-SS2-PV	250	11*1	300	9*1
GD100-1R5G-SS2-PV	250	11*1	300	9*1
GD100-2R2G-SS2-PV	250	11*1	300	9*1
GD100-0R4G-S2-PV	250	11*1	300	9*1
GD100-0R7G-S2-PV	250	11*1	300	9*1
GD100-1R5G-S2-PV	250	11*1	300	9*1
GD100-2R2G-S2-PV	250	11*1	300	9*1
GD100-1R5G-2-PV	250	11*1	300	9*1
GD100-2R2G-2-PV	250	11*1	300	9*1
GD100-004G-2-PV	250	11*2	300	9*2
GD100-5R5G-2-PV	250	11*3	300	9*3
GD100-7R5G-2-PV	250	11*4	300	9*4
GD100-0R7G-4-PV	250	18*1	300	15*1
GD100-1R5G-4-PV	250	18*1	300	15*1
GD100-2R2G-4-PV	250	18*1	300	15*1
GD100-004G-4-PV	250	20*1	300	16*1
GD100-5R5G-4-PV	250	18*2	300	15*2
GD100-7R5G-4-PV	250	18*2	300	15*2
GD100-011G-4-PV	250	18*3	300	15*3
GD100-015G-4-PV	250	18*4	300	15*4
GD100-018G-4-PV	250	18*5	300	15*5
GD100-022G-4-PV	250	18*6	300	15*6
GD100-030G-4-PV	250	18*8	300	15*8
GD100-037G-4-PV	250	18*9	300	15*9
GD100-045G-4-PV	250	18*11	300	15*11
GD100-055G-4-PV	250	18*14	300	15*14
GD100-075G-4-PV	250	18*19	300	15*19

Solar pumping inverter model	Open-circuit voltage degree of solar module			
	37±1V		45±1V	
	Module power±5Wp	Modules per string * strings	Module power±5Wp	Modules per string * strings
GD100-090G-4-PV	250	18*22	300	15*22
GD100-110G-4-PV	250	18*27	300	15*27
GD100-132G-4-PV	250	18*38	300	15*38
GD100-160G-4-PV	250	18*46	300	15*46
GD100-185G-4-PV	250	18*53	300	15*53
GD100-200G-4-PV	250	18*57	300	15*57

B.2 Recommended configuration for inverters with the boost module

PP100-3R2-PV + Solar pumping inverter	Max. DC input current	Open-circuit voltage degree of solar module			
		37±1V		45±1V	
	(A)	Module power±5Wp	Modules per string * strings	Module power±5Wp	Modules per string * strings
GD100-0R4G-SS2-PV	12	250	4*1	300	3*1
GD100-0R7G-SS2-PV	12	250	5*1	300	4*1
GD100-1R5G-SS2-PV	12	250	8*1	300	7*1
GD100-0R4G-S2-PV	12	250	4*1	300	3*1
GD100-0R7G-S2-PV	12	250	5*1	300	4*1
GD100-1R5G-S2-PV	12	250	8*1	300	7*1
GD100-1R5G-2-PV	12	250	8*1	300	7*1
GD100-2R2G-2-PV	12	250	13*1	300	11*1
GD100-0R7G-4-PV	12	250	5*1	300	4*1
GD100-1R5G-4-PV	12	250	8*1	300	7*1
GD100-2R2G-4-PV	12	250	13*1	300	11*1

Appendix C Power frequency & PV switching solution

C.1 Solution introduction

Generally, inverters do not allow simultaneous connection to power frequency and PV. If such simultaneous connection is required, switching control circuit must be configured externally.

The figure below shows the solution for reference.

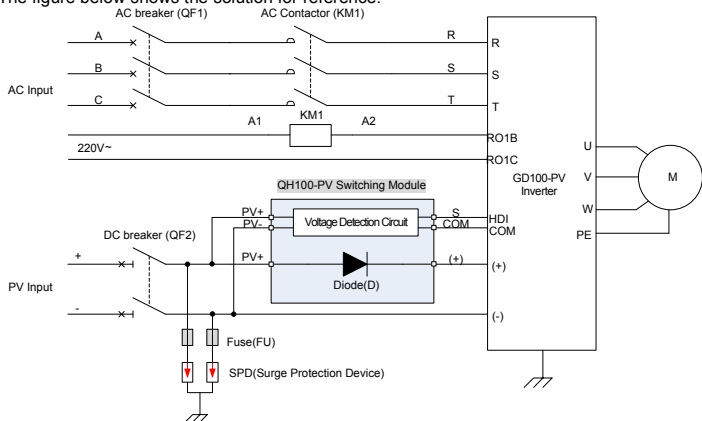

Figure C-1 Inverter power frequency & PV switching solution

See C.1.1 for specifications and model selection of QH100-PV switching module, whose necessary low-voltage apparatuses include QF1, KM1, QF2, FU, and SPD. C.1.2 details the models.

C.1.1 QH100-PV switching module

C.1.1.1 Models and specifications

QH100 - 055A - 4 - PV

①

②

③

④

Key	Sign	Description	Remarks
Product abbreviation	①	Product abbreviation	QH100 series power frequency&PV switching module
Rated	②	Inverter power	055A: applies to inverters ≤15kW

Key	Sign	Description	Remarks
current			110A: applies to inverters 18.5–37kW
Voltage degree		Voltage degree	4: AC 3PH 380V (-15%)–440 (+10%) 2: AC 3PH 220V (-15%)–240 (+10%)
Industrial code	④	Industrial code	PV stands for solar pumping.

C.1.1.2 Terminals of QH100-PV switching module

Terminal	Name	Function
PV +	PV input	Connects to the voltage detection board input and diode module positive pole.
PV –	PV input	Connects to the voltage detection board input.
(+)	Switching module output	Connects to the diode module negative pole.
S, COM	Voltage detection signal	Switching on/off signal, corresponding to PV voltage higher/lower than the threshold. Connects to inverter terminals HDI and COM.

C.1.1.3 Installation dimensions

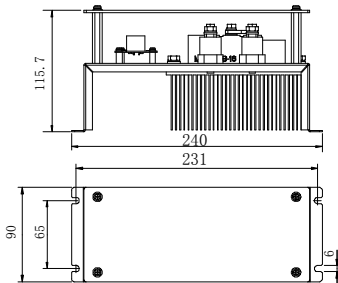

Figure C-2 Switching module installation dimensions (unit: mm)

Note: To ensure the secure running, add external ventilation and heat dissipation measures.

C.1.2 Model selection reference for low-voltage apparatus

Model	AC breaker (A)	DC breaker (A)	AC contactor (A)	SPD	Fuse	Diode I_{FAV}/V_{RRM}
GD100-0R4G-S2-PV-AS	16	16A/ 1000VDC	16	Type II, 1000V DC	30A	25A/16 00V
GD100-0R7G-S2-PV-AS	16		16			
GD100-0R4G-SS2-PV-AS	16		16			
GD100-1R5G-2-PV-AS	16		16			
GD100-1R5G-S2-PV-AS	25		25			
GD100-0R7G-SS2-PV-AS	16		16			
GD100-2R2G-S2-PV-AS	40		40			
GD100-1R5G-SS2-PV-AS	25		25			
GD100-2R2G-SS2-PV-AS	40		40			
GD100-0R7G-4-PV-AS	10		12			
GD100-1R5G-4-PV-AS	10		12			
GD100-2R2G-4-PV-AS	10		12			
GD100-004G-4-PV-AS	25		25			
GD100-5R5G-4-PV-AS	25	25A/ 1000VDC	25			55A/ 1600V
GD100-2R2G-2-PV-AS	25		25			
GD100-004G-2-PV-AS	25		25			
GD100-7R5G-4-PV-AS	40	40				
GD100-5R5G-2-PV-AS	40	63A/ 1000VDC	40			
GD100-011G-4-PV-AS	50		50			
GD100-7R5G-2-PV-AS	50		50			
GD100-015G-4-PV-AS	63	63				
GD100-018G-4-PV-AS	63	100A/ 1000VDC	63	110A/ 1600V		
GD100-022G-4-PV-AS	100		95			
GD100-030G-4-PV-AS	100		95			
GD100-037G-4-PV-AS	125	125A/ 1000VDC	115			

Model	AC breaker (A)	DC breaker (A)	AC contactor (A)	SPD	Fuse	Diode I_{FAV}/V_{RRM}
GD100-045G-4-PV-AS	200	160A/ 1000VDC	170			160A/ 1600V
GD100-055G-4-PV-AS	200	250A/ 1000VDC	170			250A/ 1600V
GD100-075G-4-PV-AS	250		205			
GD100-090G-4-PV-AS	315	350A/ 1000VDC	245			350A/ 1600V
GD100-110G-4-PV-AS	350		265			
GD100-132G-4-PV-AS	350	400A/ 1000VDC	330			400A/ 1600V
GD100-160G-4-PV-AS	400	550A/ 1000VDC	400			550A/ 1600V
GD100-185G-4-PV-AS	500		500			
GD100-200G-4-PV-AS	500	600A/ 1000VDC	500			600A/ 1600V

C.2 IP54 protection-level inverters

INVT provides IP54 protection-level inverters, which are divided into two types: One type implements auto power frequency & PV switching and the other type does not implement auto switching.

The figure below shows the inverter dimensions.

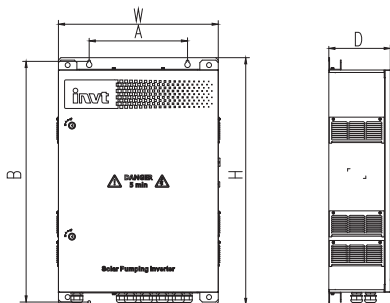

Figure C-2 IP54 inverter dimensional drawing

IP54 inverter dimensions (unit: mm)

Power (kW)	Model	W	H	D	A	B
37	GD100-037G-45-PV-AS	650	1000	250	400	975
30	GD100-030G-45-PV-AS					
22	GD100-022G-45-PV-AS					
18.5	GD100-018G-45-PV-AS					
15	GD100-015G-45-PV-AS	550	900	225	400	875
11	GD100-011G-45-PV-AS					
7.5	GD100-7R5G-45-PV-AS					
	GD100-7R5G-25-PV-AS					
5.5	GD100-5R5G-45-PV-AS					
	GD100-5R5G-25-PV-AS					
4	GD100-004G-45-PV-AS					

Power (kW)	Model	W	H	D	A	B
	GD100-004G-25-PV-AS					
2.2	GD100-2R2G-45-PV-AS	550	700	200	400	675
	GD100-2R2G-S25-PV-AS					
	GD100-2R2G-SS25-PV-AS					
1.5	GD100-1R5G-45-PV-AS					
	GD100-1R5G-S25-PV-AS					
	GD100-1R5G-SS25-PV-AS					
0.75	GD100-0R7G-45-PV-AS					
	GD100-0R7G-S25-PV-AS					
	GD100-0R7G-SS25-PV-AS					
0.4	GD100-0R4G-S25-PV-AS					
	GD100-0R4G-SS25-PV-AS					

Note:

1. The inverters that do not implement auto switching do not have the suffix -AS.
2. The inverters $\leq 2.2\text{kW}$ are equipped with the boost module, supporting auto switching.
3. For -S25 and -SS25 models with the boost module, the DC input voltage cannot be greater than 440V. For -45 models with the boost module, the DC input voltage cannot be greater than 600V.

C.3 Wiring terminals

The following figures show the wiring terminals of different models for IP54 inverters.

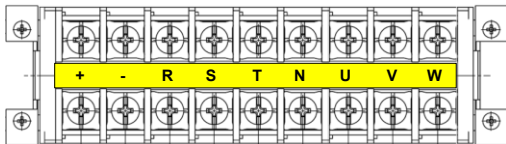
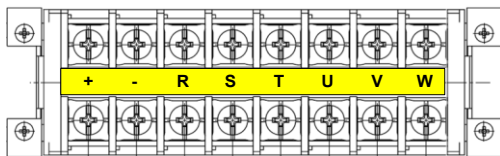
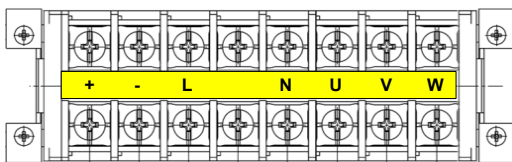

Figure C-3 Wiring terminals of 4-37kW models

Figure C-4 Wiring terminals of -4 models for inverters $\leq 2.2\text{kW}$ Figure C-5 Wiring terminals of -S2/-SS2 models for inverters $\leq 2.2\text{kW}$

Wiring terminal functions

Terminal	Name	Function
R, S, T	AC input	3PH 380/220V AC input terminals, connected to the grid
N		Neutral wire. For 4-37kW models, use 3PH 4-wire distribution system and connect the neutral wire to terminal N.
L, N	AC input	1PH 220V AC input terminals, connected to the grid
(+), (-)	PV input	Solar cell panel input terminals
U, V, W	Inverter output	3PH/1PH AC output terminals, connected to pump motor Note: 1PH motors must connect to terminals U and W.
⊕	Safety grounding	Safety grounding terminal. Each inverter must be grounded properly. Note: It is at the bottom of the chassis.

C.4 Parameter setting method

Connect the external PV voltage detection signal to the HDI terminal (auto switching by default). Ensure that the PV voltage detection threshold is 300V for the -4 models and it is 200V for the -2/-S2/-SS2 models. After the correct connection, set P15.32 to 0.

Appendix D Dimension drawings

D.1 External keypad structure

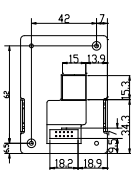
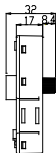
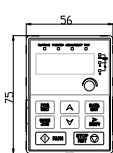

Keypad structure

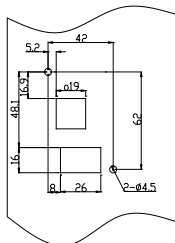

Installation hole

Note: The external keypad is optional for the inverters (380V; $\leq 2.2\text{kW}$) and the standard keypad of inverters (380V; $\geq 4\text{kW}$) can be used as the external keypad.

If the keypad is externally installed on an optional bracket, it can be 20 meters away from the inverter at most.

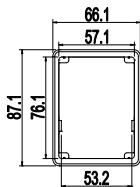

Installation bracket

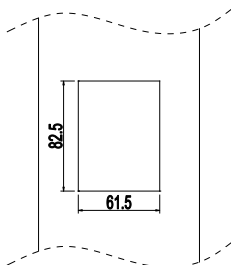

Installation dimension

D.2 Dimensions of 0.4-2.2kW models

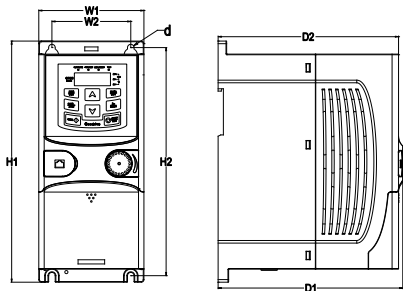

(a) Wall mounting

Dimensions in wall mounting (unit: mm)

Model	W1	W2	H1	H2	D1	D2	Installation hole (d)
GD100-0R4G-S2-PV	80.0	60.0	160.0	150.0	123.5	120.3	5
GD100-0R7G-S2-PV	80.0	60.0	160.0	150.0	123.5	120.3	5
GD100-0R4G-SS2-PV	80.0	60.0	160.0	150.0	123.5	120.3	5
GD100-1R5G-S2-PV	80.0	60.0	185.0	175.0	140.5	137.3	5
GD100-2R2G-S2-PV	80.0	60.0	185.0	175.0	140.5	137.3	5
GD100-0R7G-SS2-PV	80.0	60.0	185.0	175.0	140.5	137.3	5
GD100-1R5G-SS2-PV	80.0	60.0	185.0	175.0	140.5	137.3	5
GD100-2R2G-SS2-PV	80.0	60.0	185.0	175.0	140.5	137.3	5
GD100-0R7G-4-PV	80.0	60.0	185.0	175.0	140.5	137.3	5
GD100-1R5G-4-PV	80.0	60.0	185.0	175.0	140.5	137.3	5
GD100-2R2G-4-PV	80.0	60.0	185.0	175.0	140.5	137.3	5

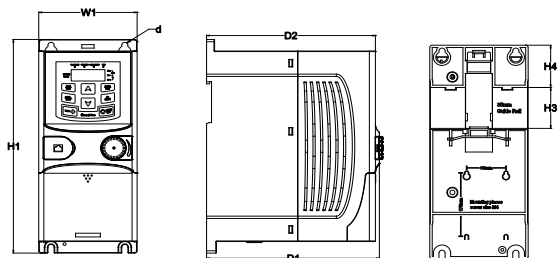

(b) Rail mounting

Dimensions in rail mounting (unit: mm)

Model	W1	H1	H3	H4	D1	D2	Installation hole (d)
GD100-0R4G-S2-PV	80.0	160.0	35.4	36.6	123.5	120.3	5
GD100-0R7G-S2-PV	80.0	160.0	35.4	36.6	123.5	120.3	5
GD100-0R4G-SS2-PV	80.0	160.0	35.4	36.6	123.5	120.3	5
GD100-1R5G-S2-PV	80.0	185.0	35.4	36.6	140.5	137.3	5
GD100-2R2G-S2-PV	80.0	185.0	35.4	36.6	140.5	137.3	5
GD100-0R7G-SS2-PV	80.0	185.0	35.4	36.6	140.5	137.3	5
GD100-1R5G-SS2-PV	80.0	185.0	35.4	36.6	140.5	137.3	5
GD100-2R2G-SS2-PV	80.0	185.0	35.4	36.6	140.5	137.3	5
GD100-0R7G-4-PV	80.0	185.0	35.4	36.6	140.5	137.3	5
GD100-1R5G-4-PV	80.0	185.0	35.4	36.6	140.5	137.3	5
GD100-2R2G-4-PV	80.0	185.0	35.4	36.6	140.5	137.3	5

D.3 Dimensions of 1.5-200kW models

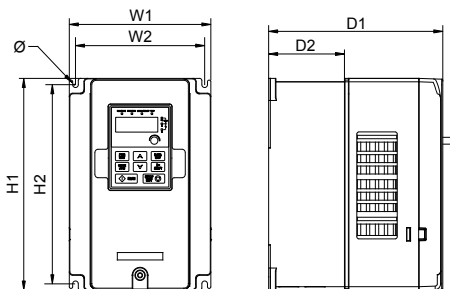

(a) Wall mounting

Dimensions in wall mounting (unit: mm)

Model	W1	W2	H1	H2	D1	D2	Installation hole (d)
GD100-1R5G-2-PV	146.0	131.0	256.0	243.5	167.0	84.5	6
GD100-2R2G-2-PV	146.0	131.0	256.0	243.5	167.0	84.5	6
GD100-004G-4-PV	146.0	131.0	256.0	243.5	167.0	84.5	6
GD100-5R5G-4-PV	146.0	131.0	256.0	243.5	167.0	84.5	6
GD100-7R5G-4-PV	170.0	151.0	320.0	303.5	196.3	113.0	6
GD100-011G-4-PV	170.0	151.0	320.0	303.5	196.3	113.0	6
GD100-015G-4-PV	170.0	151.0	320.0	303.5	196.3	113.0	6
GD100-004G-2-PV	170.0	151.0	320.0	303.5	196.3	113.0	6
GD100-5R5G-2-PV	170.0	151.0	320.0	303.5	196.3	113.0	6
GD100-7R5G-2-PV	170.0	151.0	320.0	303.5	196.3	113.0	6
GD100-018G-4-PV	200.0	185.0	340.6	328.6	184.3	104.5	6
GD100-022G-4-PV	200.0	185.0	340.6	328.6	184.3	104.5	6
GD100-030G-4-PV	250.0	230.0	400.0	380.0	202.0	123.5	6
GD100-037G-4-PV	250.0	230.0	400.0	380.0	202.0	123.5	6
GD100-045G-4-PV	282.0	160.0	560.0	542.4	238.0	138.0	9
GD100-055G-4-PV	282.0	160.0	560.0	542.4	238.0	138.0	9

Model	W1	W2	H1	H2	D1	D2	Installation hole (d)
GD100-075G-4-PV	282.0	160.0	560.0	542.4	238.0	138.0	9
GD100-090G-4-PV	338.0	200.0	554.0	534.0	326.2	--	9.5
GD100-110G-4-PV	338.0	200.0	554.0	534.0	326.2	--	9.5
GD100-132G-4-PV	500.0	360.0	870.0	850.0	360.0	--	11
GD100-160G-4-PV	500.0	360.0	870.0	850.0	360.0	--	11
GD100-185G-4-PV	500.0	360.0	870.0	850.0	360.0	--	11
GD100-200G-4-PV	500.0	360.0	870.0	850.0	360.0	--	11

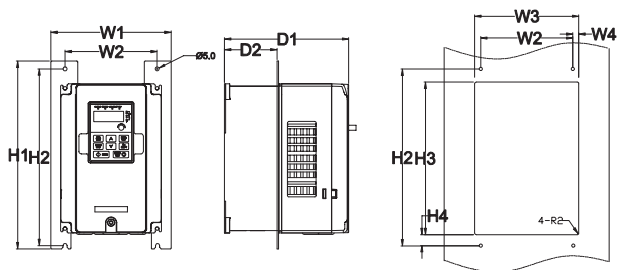

(b) Flange installation

Dimensions in flange installation (unit: mm)

Model	W1	W2	W3	W4	H1	H2	H3	H4	D1	D2	Installation hole	Nut specs
GD100-004G-4-PV	170.2	131	150	9.5	292	276	260	6	167	84.5	6	M5
GD100-5R5G-4-PV	170.2	131	150	9.5	292	276	260	6	167	84.5	6	M5
GD100-7R5G-4-PV	191.2	151	174	11.5	370	351	324	12	196.3	113	6	M5
GD100-011G-4-PV	191.2	151	174	11.5	370	351	324	12	196.3	113	6	M5
GD100-015G-4-PV	191.2	151	174	11.5	370	351	324	12	196.3	113	6	M5
GD100-1R5G-2-PV	170.2	131	150	9.5	292	276	260	6	167	84.5	6	M5
GD100-2R2G-2-PV	170.2	131	150	9.5	292	276	260	6	167	84.5	6	M5
GD100-004G-2-PV	191.2	151	174	11.5	370	351	324	12	196.3	113	6	M5
GD100-5R5G-2-PV	191.2	151	174	11.5	370	351	324	12	196.3	113	6	M5

Model	W1	W2	W3	W4	H1	H2	H3	H4	D1	D2	Installation hole	Nut specs
GD100-7R5G-2-PV	191.2	151	174	11.5	370	351	324	12	196.3	113	6	M5
GD100-018G-4-PV	266	250	224	13	371	250	350.6	20.3	184.6	104	6	M5
GD100-022G-4-PV	266	250	224	13	371	250	350.6	20.3	184.6	104	6	M5
GD100-030G-4-PV	316	300	274	13	430	300	410	55	202	118.3	6	M5
GD100-037G-4-PV	316	300	274	13	430	300	410	55	202	118.3	6	M5
GD100-045G-4-PV	352	332	306	13	580	400	570	80	238	133.8	9	M8
GD100-055G-4-PV	352	332	306	13	580	400	570	80	238	133.8	9	M8
GD100-075G-4-PV	352	332	306	13	580	400	570	80	238	133.8	9	M8
GD100-090G-4-PV	418.5	361	389.5	14.2	600	559	370	108.5	329.5	149.5	9.5	M8
GD100-110G-4-PV	418.5	361	389.5	14.2	600	559	370	108.5	329.5	149.5	9.5	M8
GD100-132G-4-PV	500	360	480	60	870	850	796	37	358	178.5	11	M10
GD100-160G-4-PV	500	360	480	60	870	850	796	37	358	178.5	11	M10
GD100-185G-4-PV	500	360	480	60	870	850	796	37	358	178.5	11	M10
GD100-200G-4-PV	500	360	480	60	870	850	796	37	358	178.5	11	M10

Note: In flange installation mode, select flange installation boards.

Appendix E Further information

E.1 Product and service inquiries

Address any inquiries about the product to your local INVT offices, quoting the type designation and serial number of the unit in question. A listing of INVT sales, support and service contacts can be found by navigating to www.invt.com.

E.2 Feedback of INVT Inverters manuals

Your comments on our manuals are welcome. Go to www.invt.com and select *Online Feedback* or *Contact Us*.

E.3 Document library on the Internet

You can find manuals and other product documents in PDF format on the Internet. Go to www.invt.com and select *Service and Support of Document Download*.



Service line:86-755-86312859

Website:www.invt.com

The products are owned by **Shenzhen INVT Electric Co.,Ltd.**

Two companies are commissioned to manufacture: (For product code, refer to the 2nd/3rd place of S/N on the name plate.)

Shenzhen INVT Electric Co., Ltd. (origin code: 01)

Address: INVT Guangming Technology Building, Songbai Road,
Matian, Guangming District, Shenzhen, China

INVT Power Electronics (Suzhou) Co., Ltd. (origin code: 06)

Address: 1# Kunlun Mountain Road, Science & Technology Town,
Gaixin District, Suzhou, Jiangsu, China

Industrial Automation: ■ Inverter ■ Servo & Motion Control ■ Motor & Electric Spindle ■ PLC

■ HMI ■ Intelligent Elevator Control System ■ Traction Drive

Electric Power: ■ SVG ■ Solar Inverter ■ UPS ■ Online Energy Management System

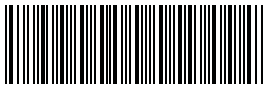

66001-00414

Copyright© INVT.

Manual information may be subject to change without prior notice.

201906 (V1.6)